



WDSS



LEARNING FROM HOME



PACK 2

This pack includes

1. reading & writing activities
2. Maths
3. Mindfulness activities

Enjoy!



My Pencil Control Workbook

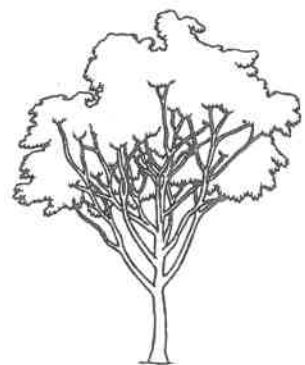
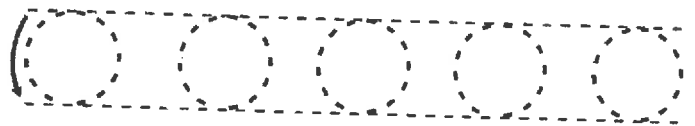
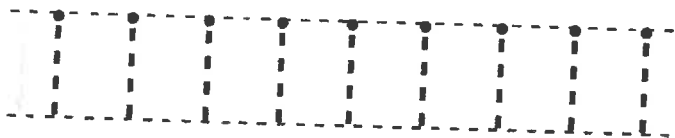
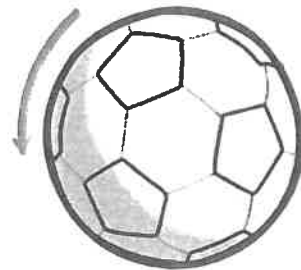
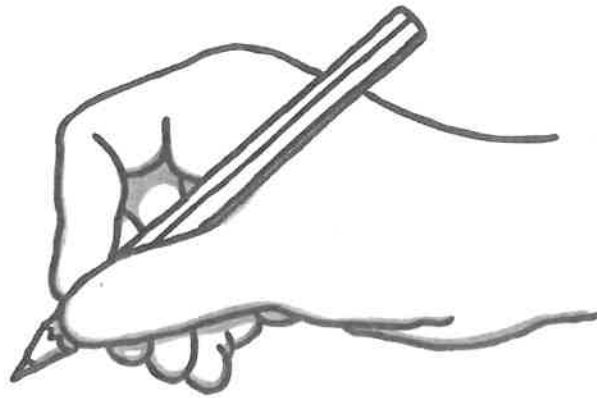

Trace the dotted lines to from top to bottom.

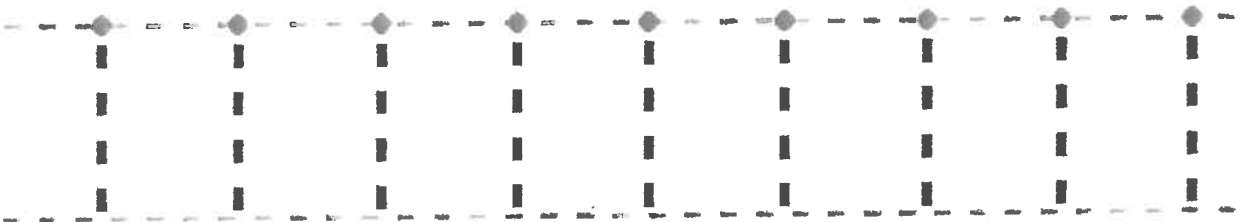
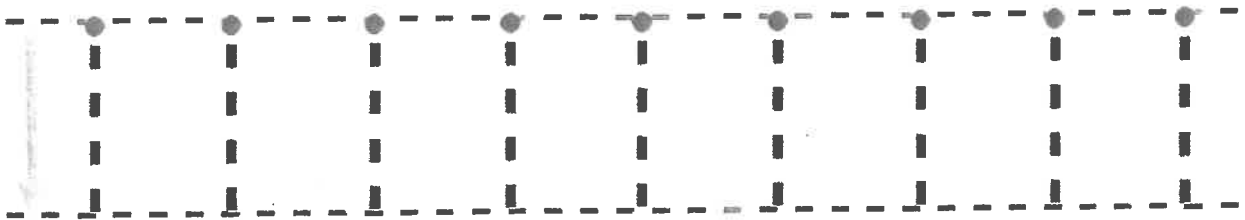

Trace the lines to help the animals get home.

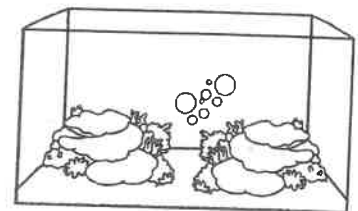
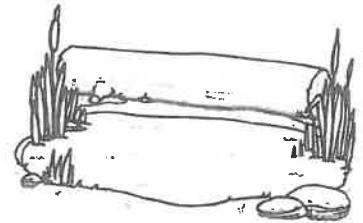
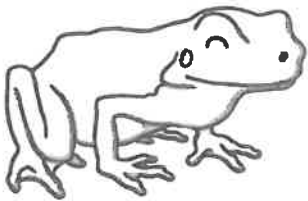
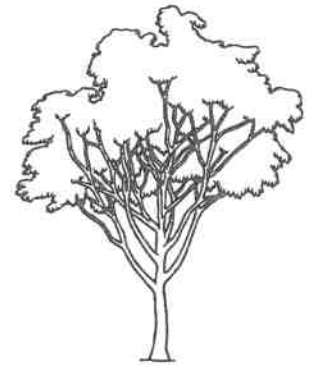
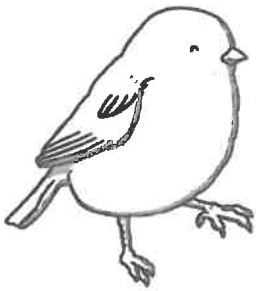

Trace the dotted lines from left to right.

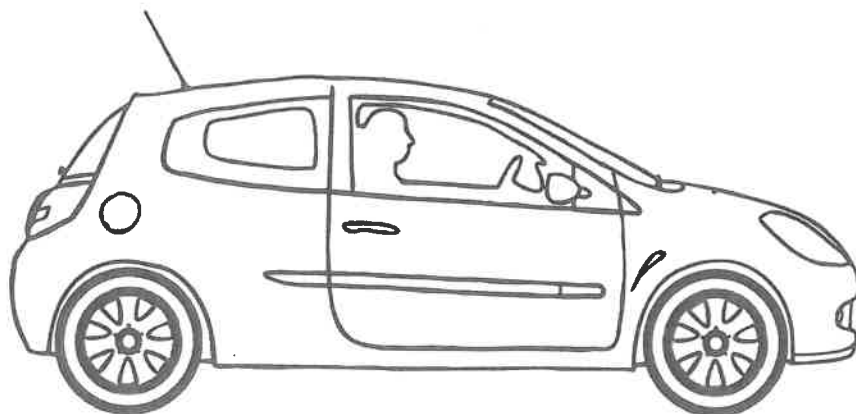

Trace the dotted lines.

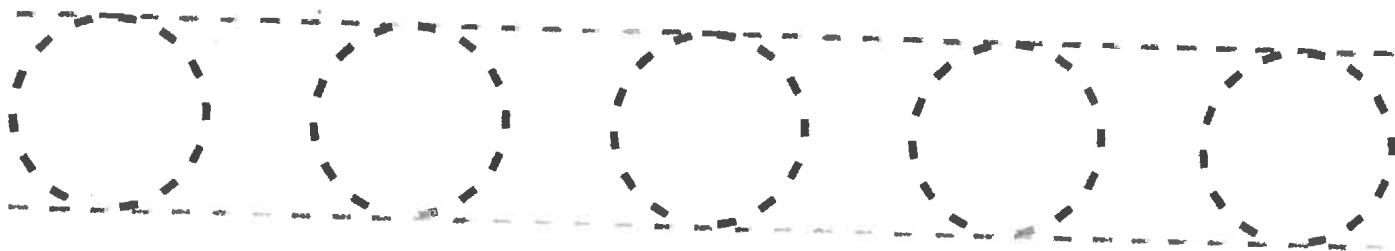
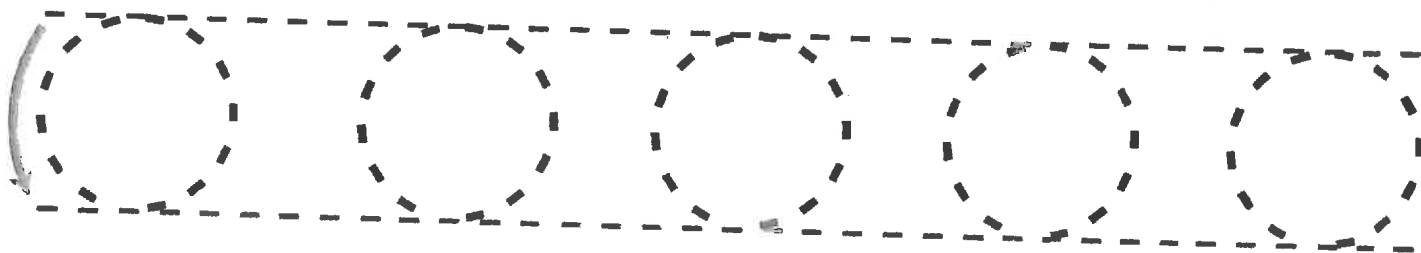
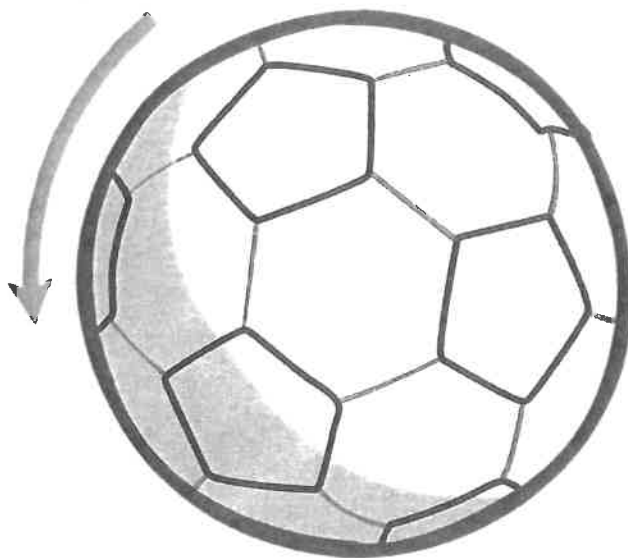

Trace the dotted lines.

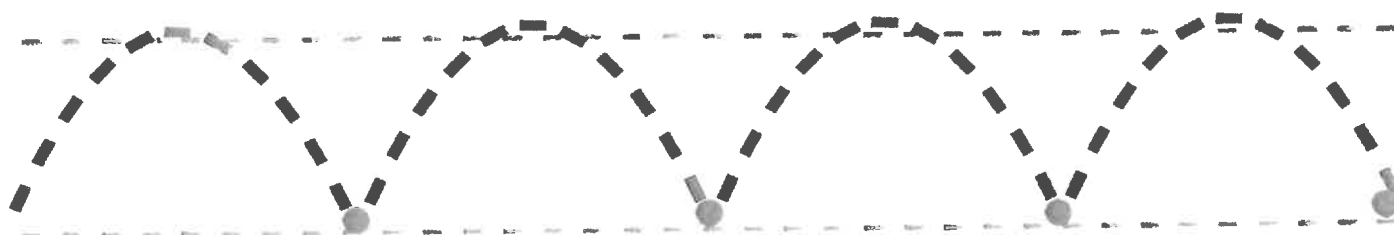
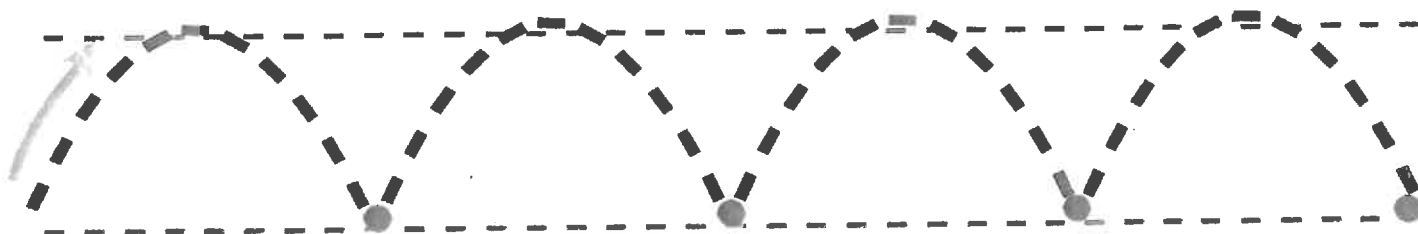
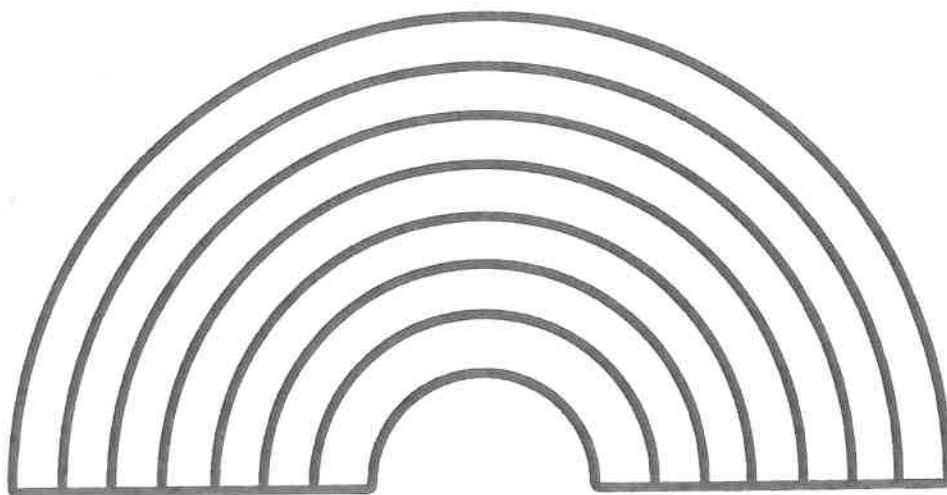

Trace the dotted lines.

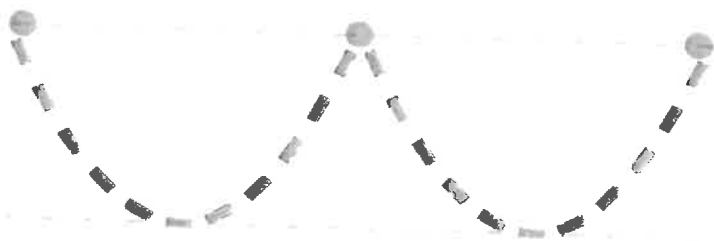
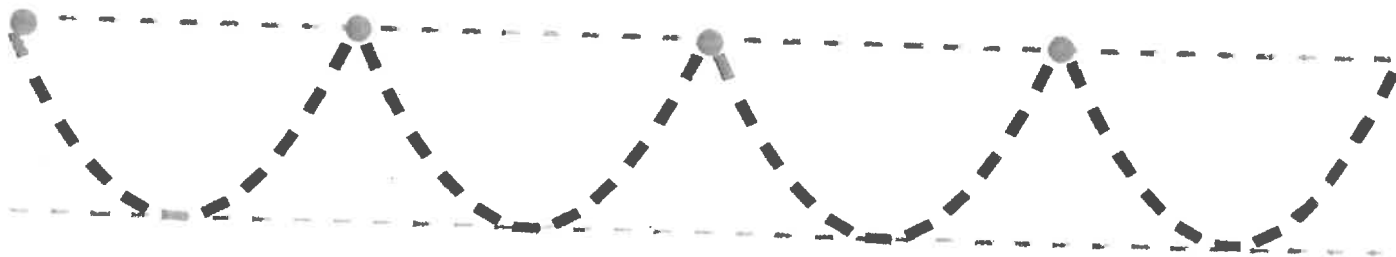
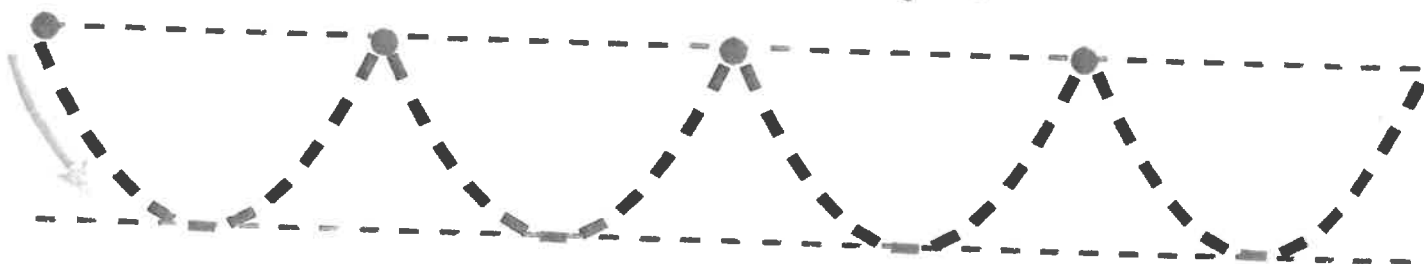

Trace the dotted lines to from top to bottom.

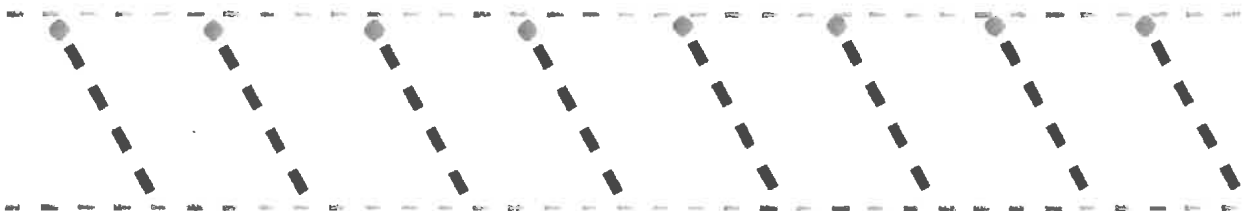
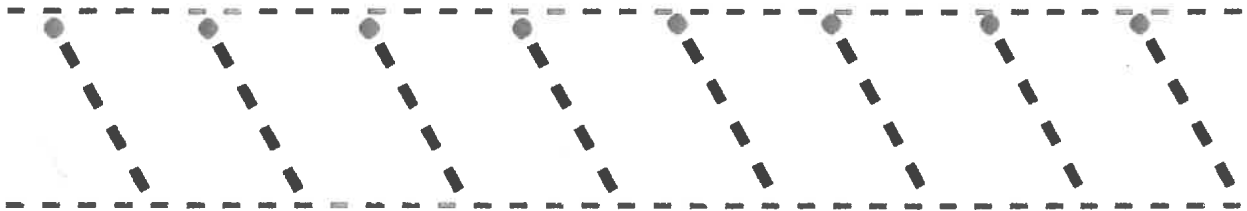
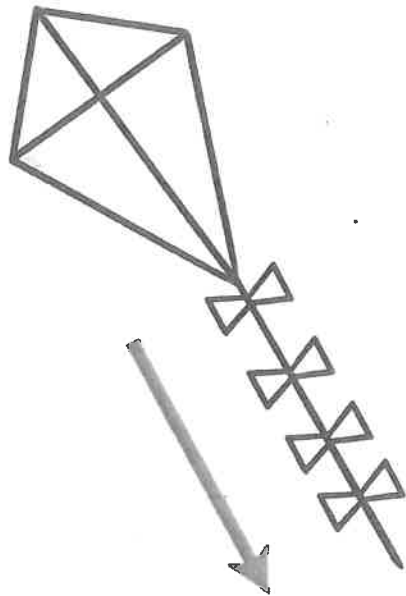

Trace the dotted lines.

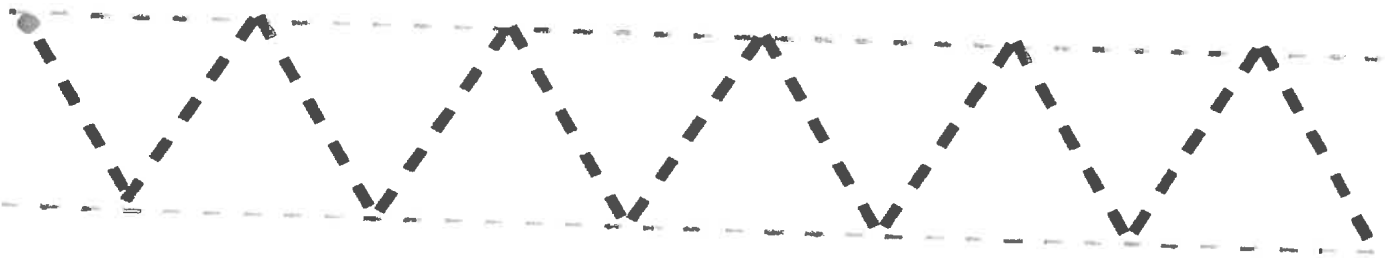
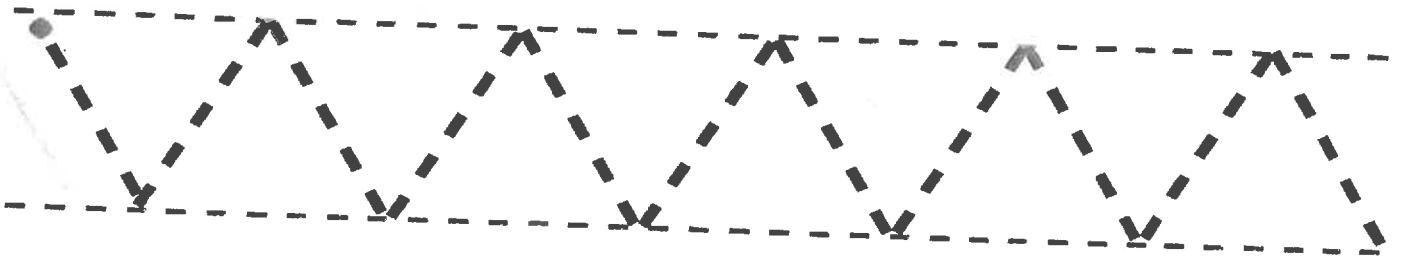
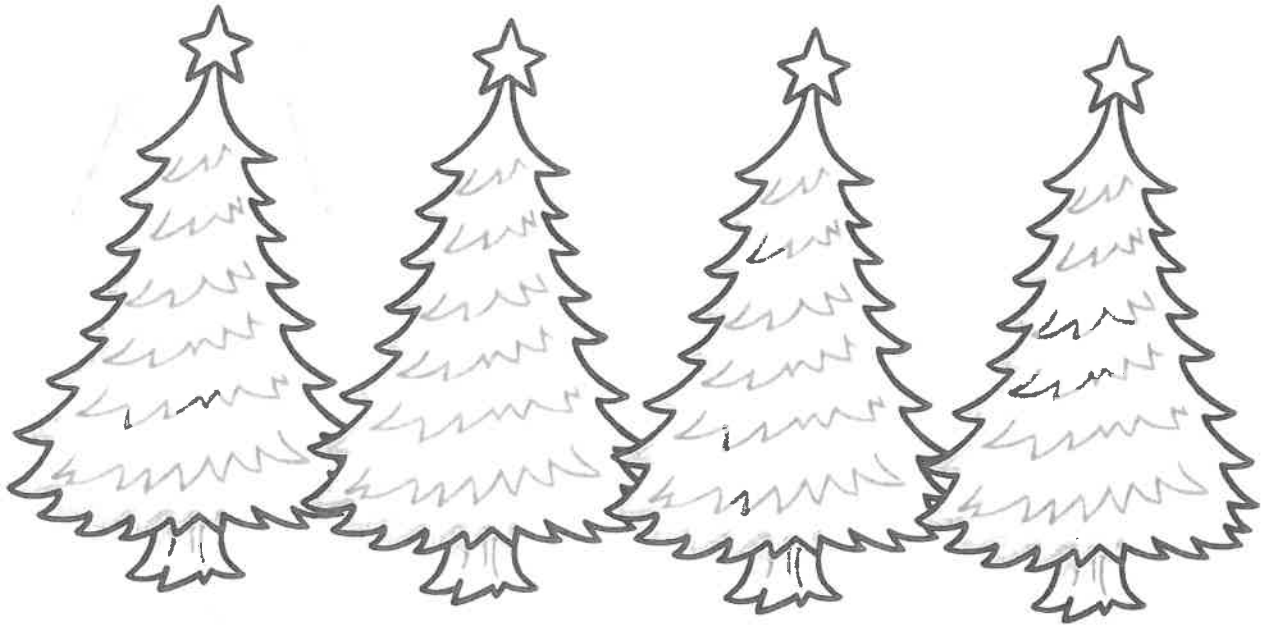

Trace the lines to help the animals get home.

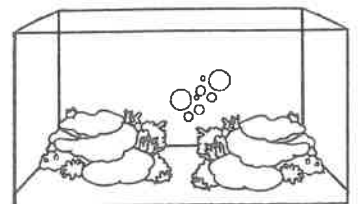
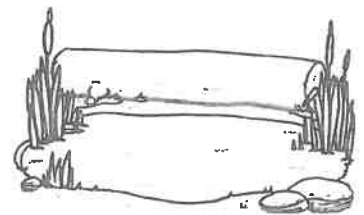
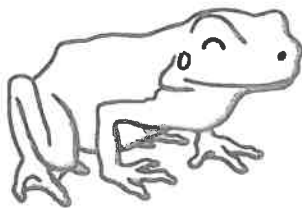
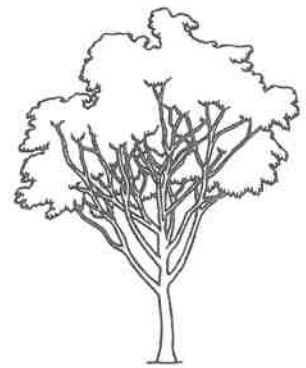
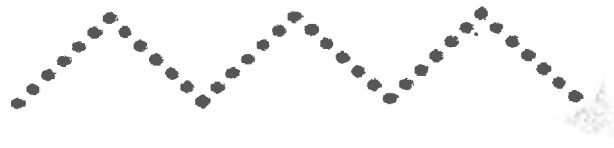
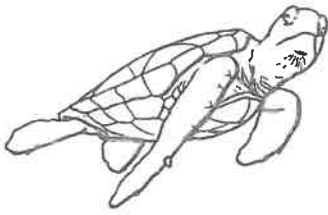

Trace the lines to help the animals get home.

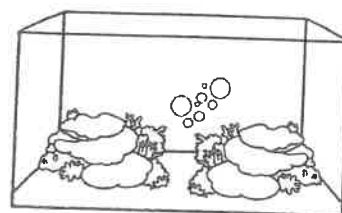
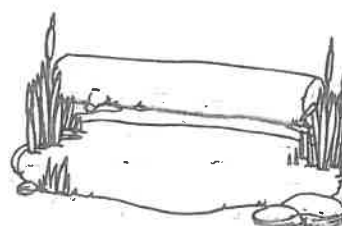
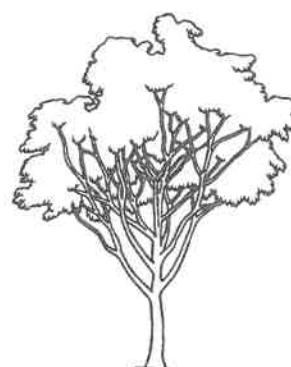

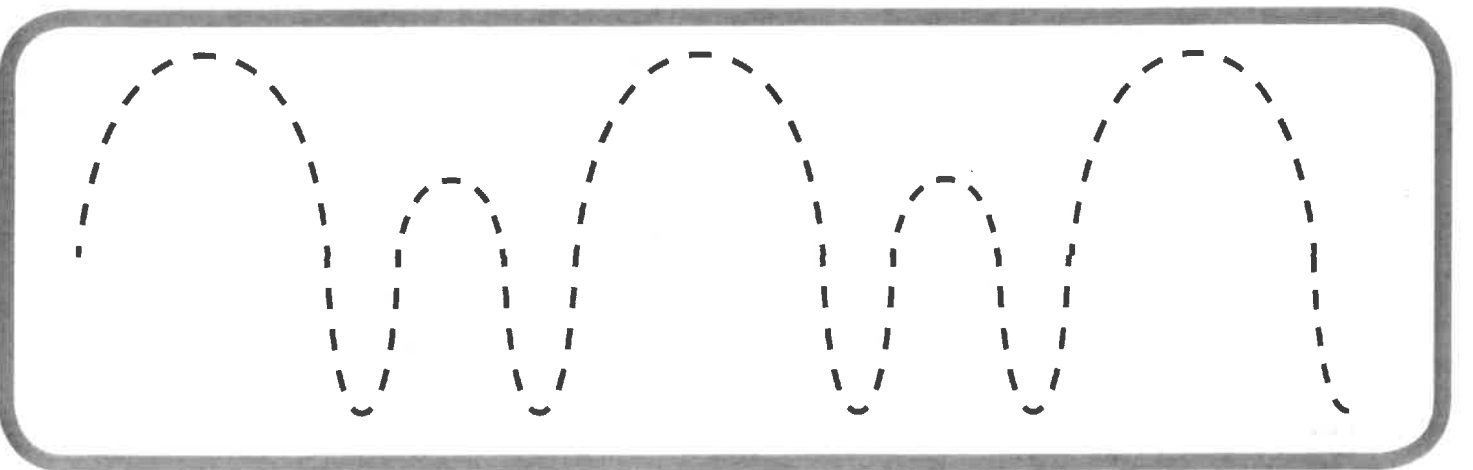
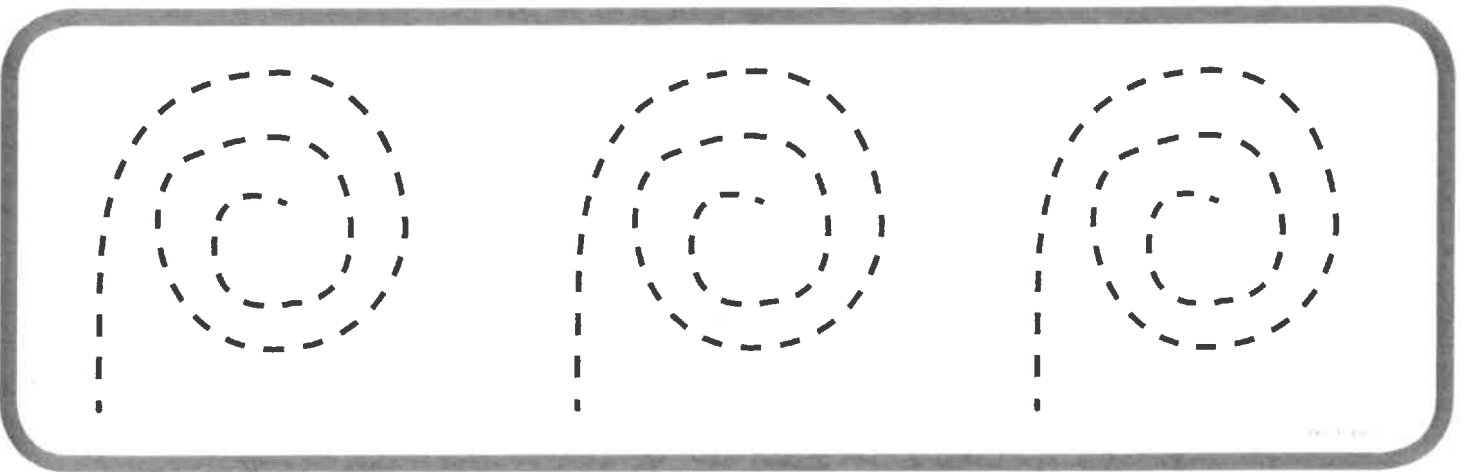
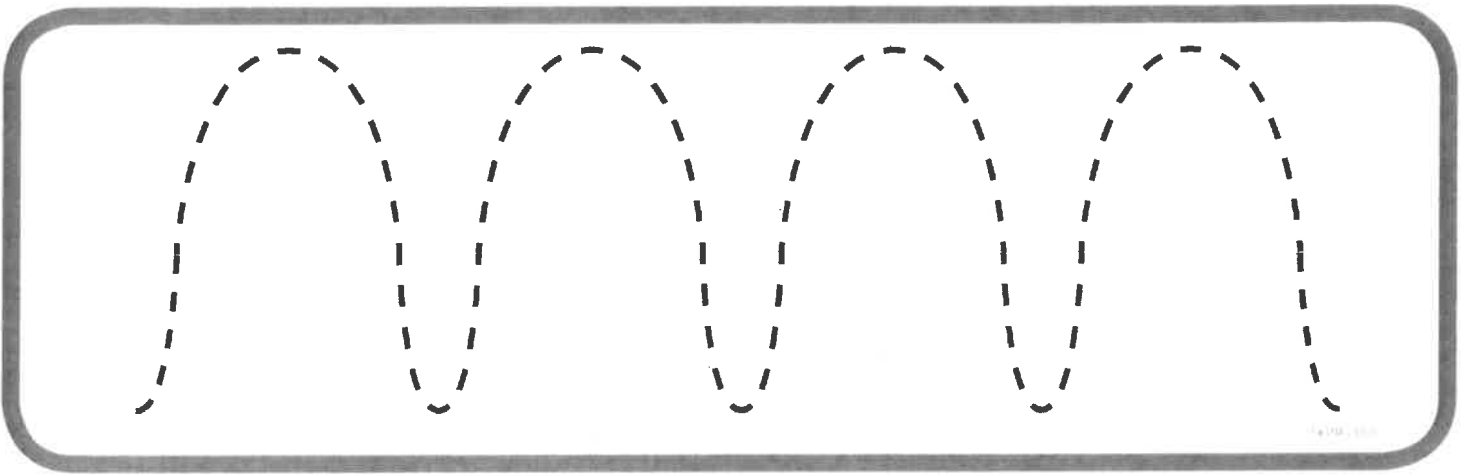
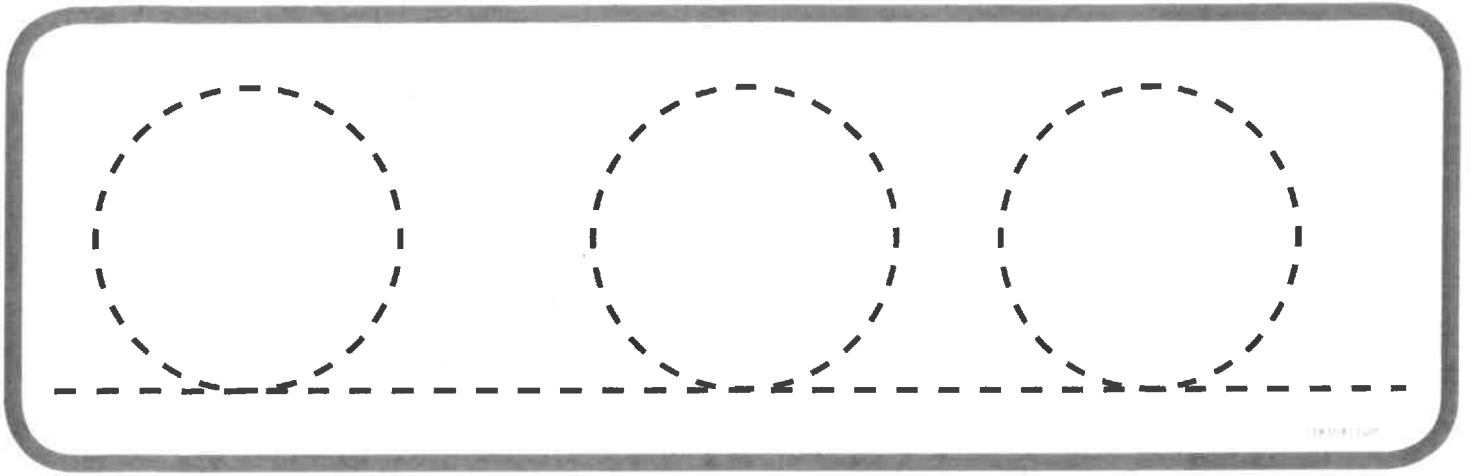

Letter and Number Tracing

Trace the letters and numbers below.

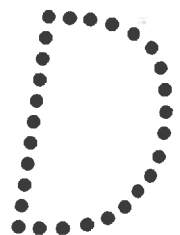
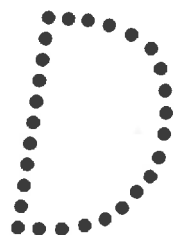
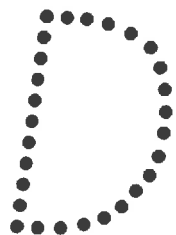
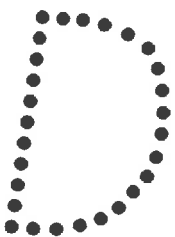
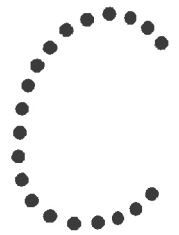
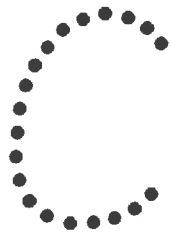
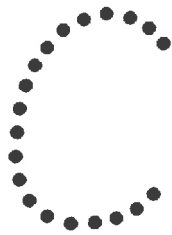
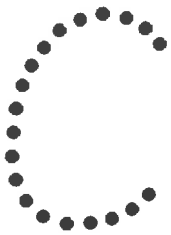
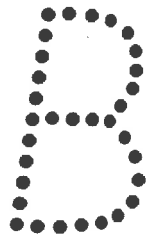
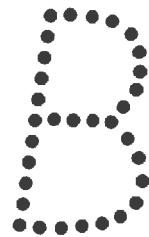
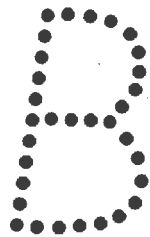
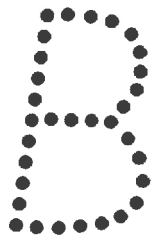
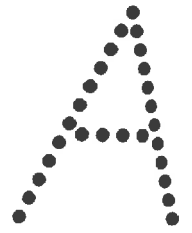
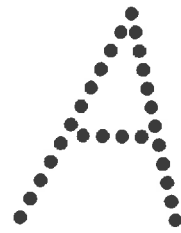
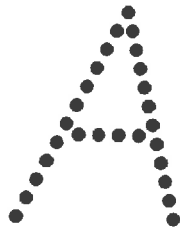
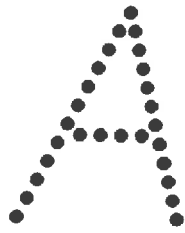
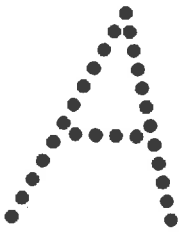

Letter and Number Tracing

Trace the letters and numbers below.

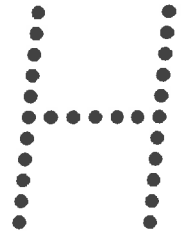
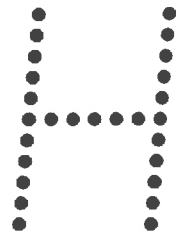
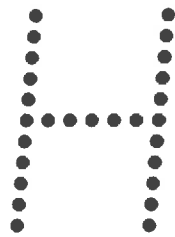
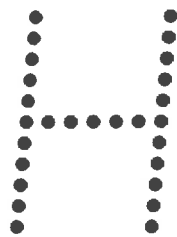
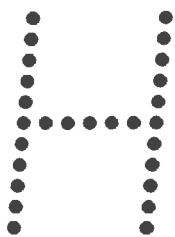
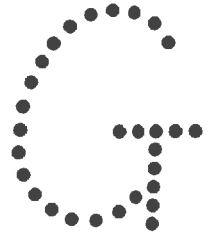
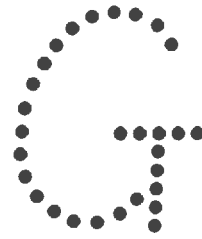
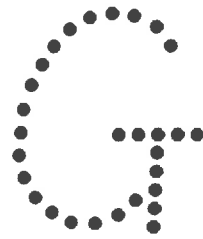
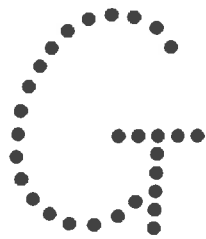
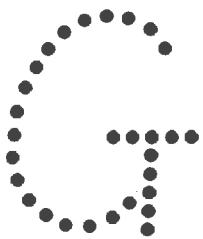
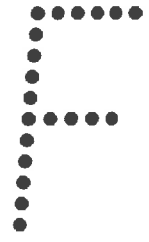
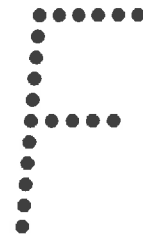
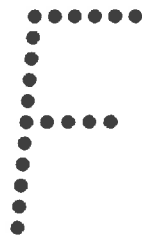
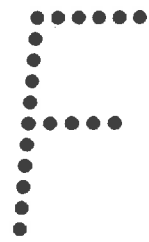
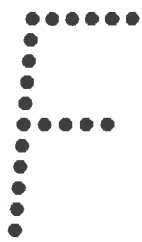
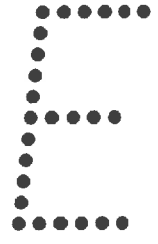
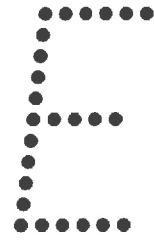
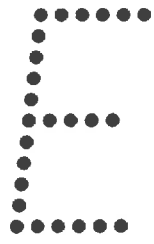
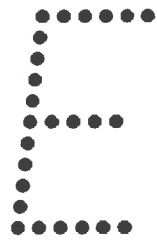
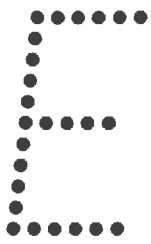

Letter and Number Tracing

Trace the letters and numbers below.

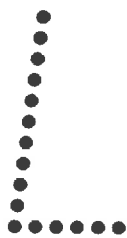
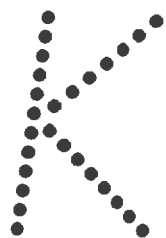
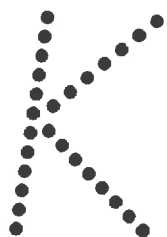
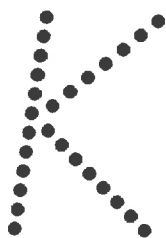
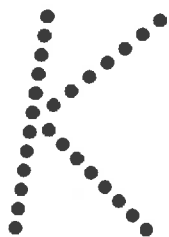
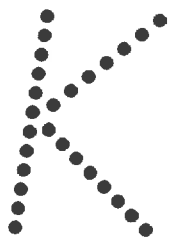
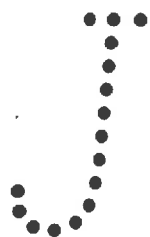
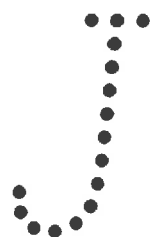
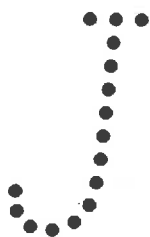
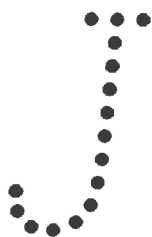
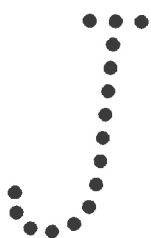
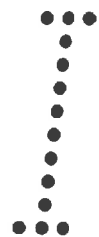
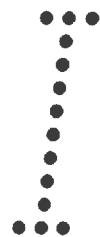
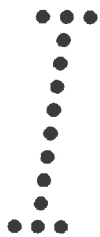
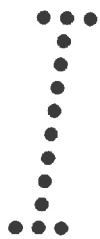

Letter and Number Tracing

Trace the letters and numbers below.

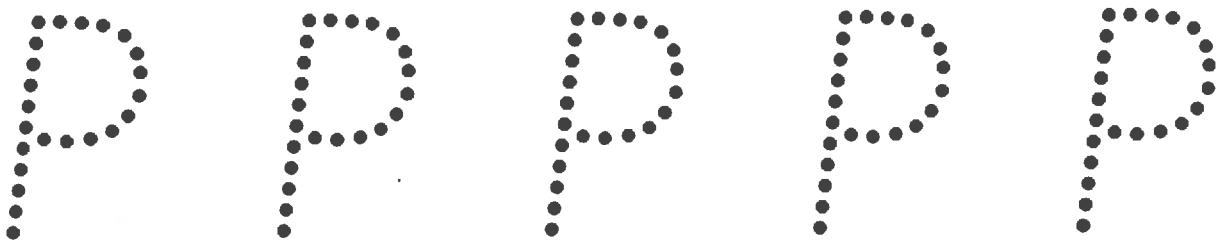
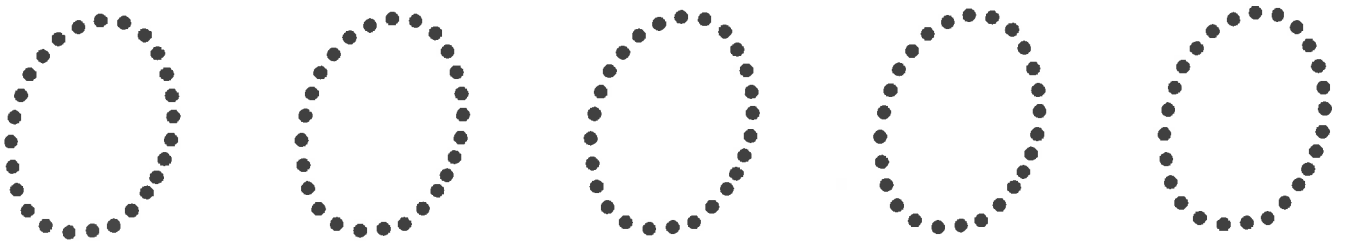
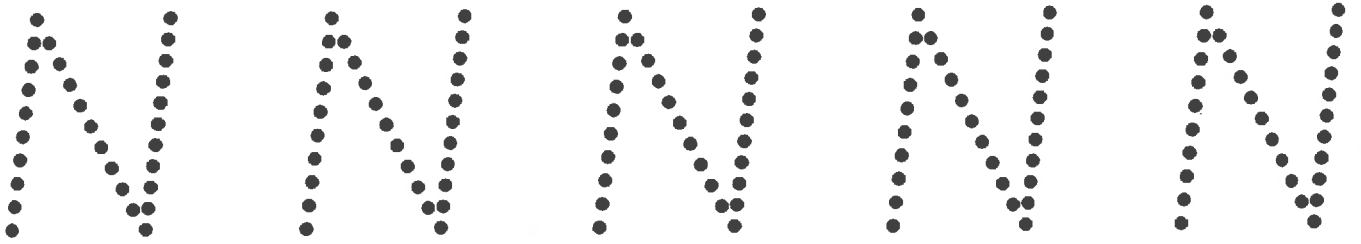
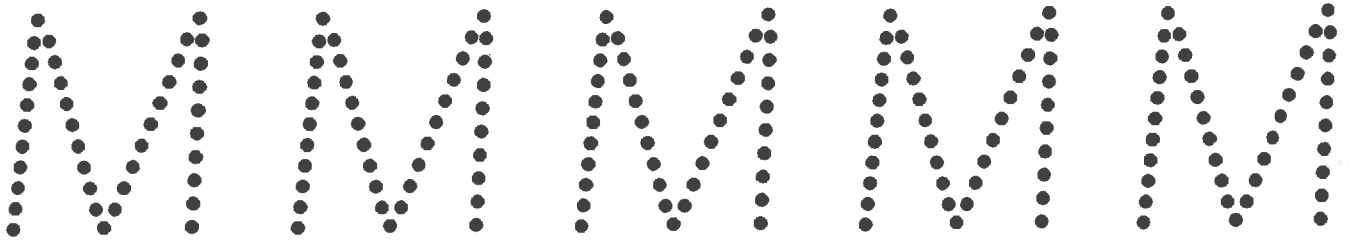

Letter and Number Tracing

Trace the letters and numbers below.

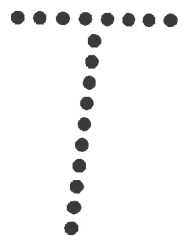
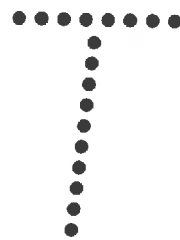
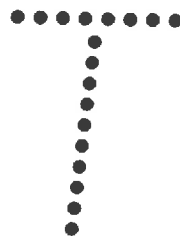
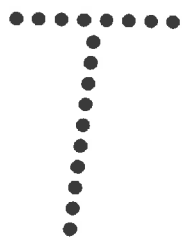
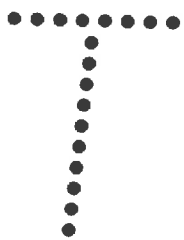
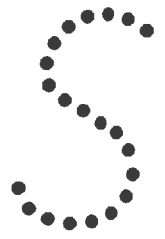
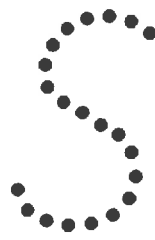
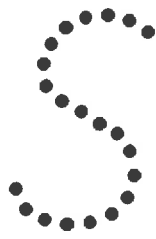
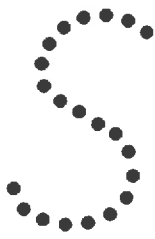
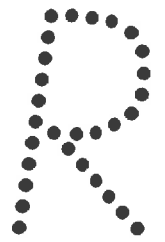
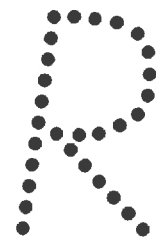
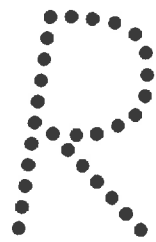
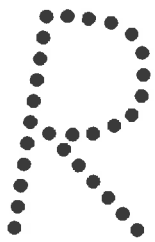
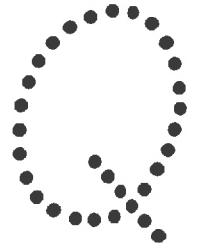
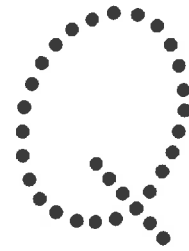
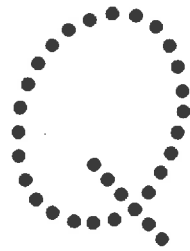
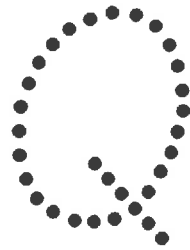
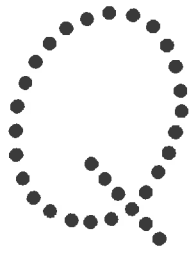

Letter and Number Tracing

Trace the letters and numbers below.

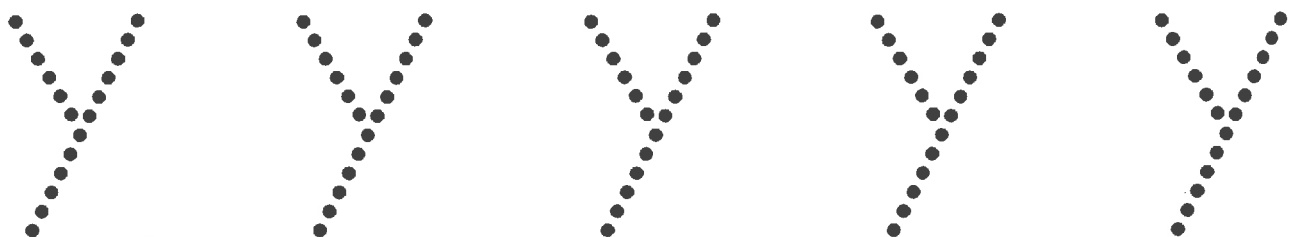
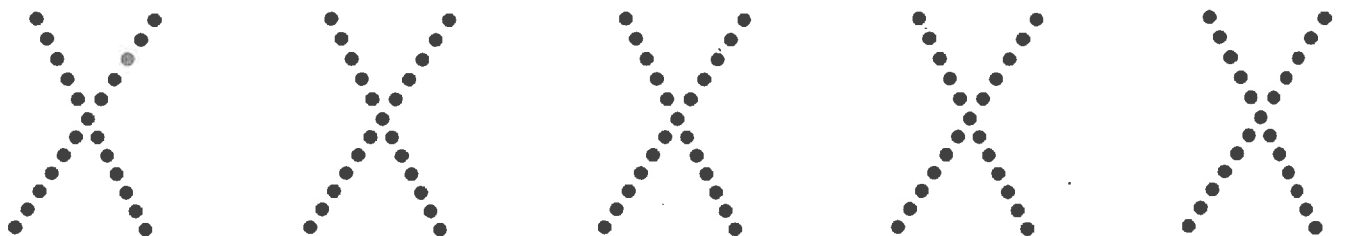
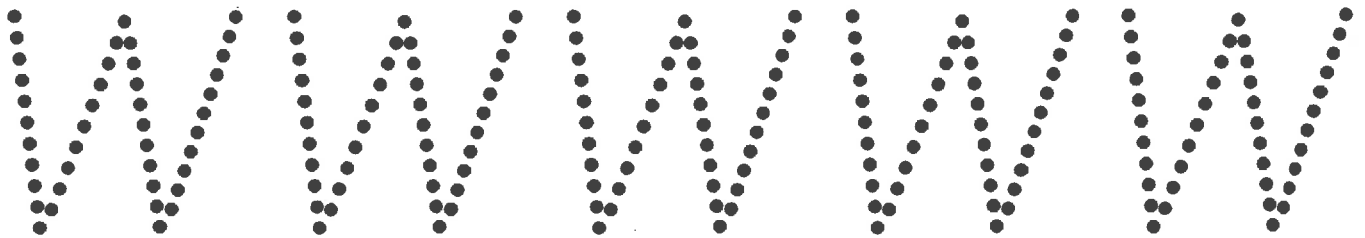
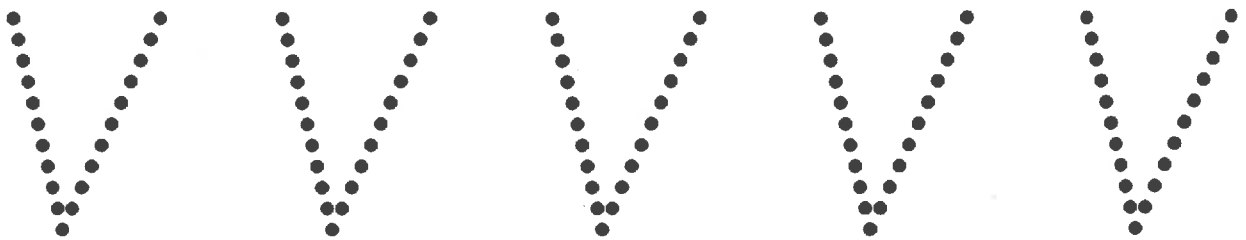
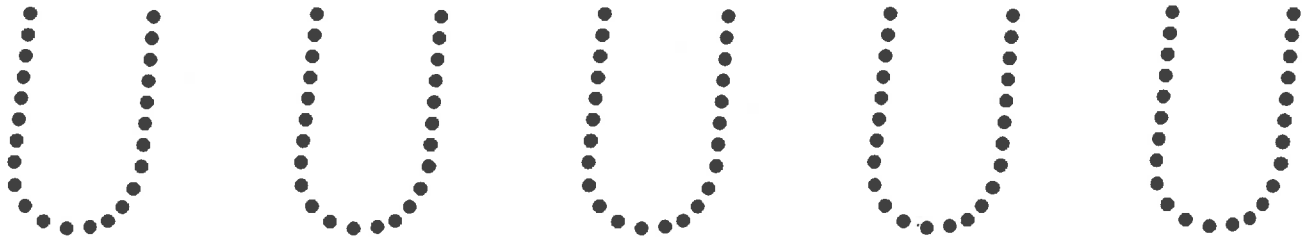

Letter and Number Tracing

Trace the letters and numbers below.

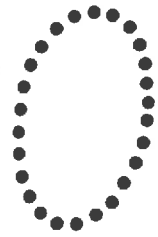
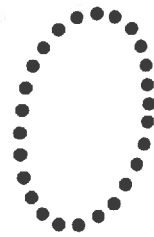
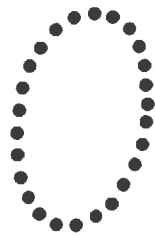
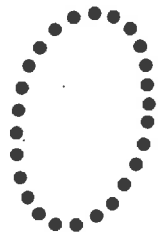
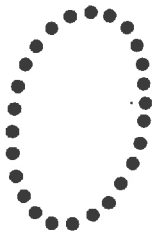
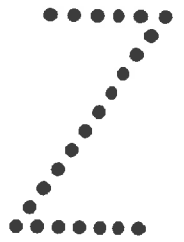
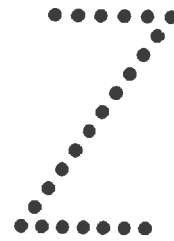
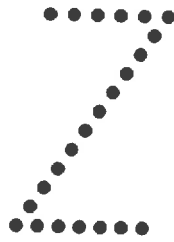
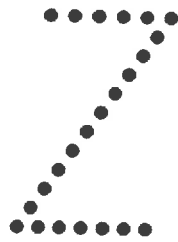
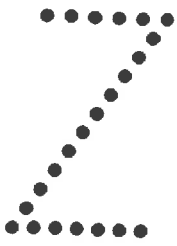

Letter and Number Tracing

Trace the letters and numbers below.

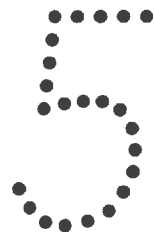
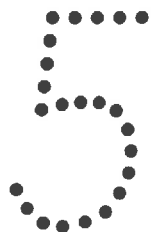
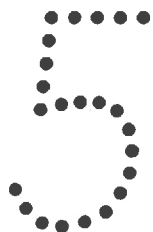
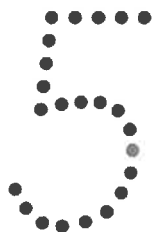
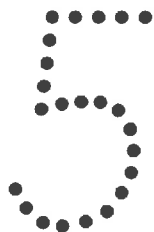
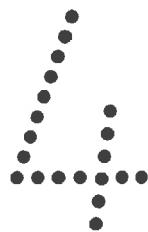
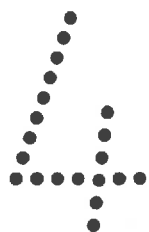

Letter and Number Tracing

Trace the letters and numbers below.

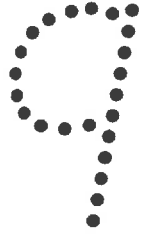
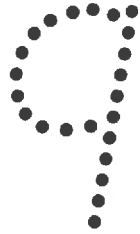
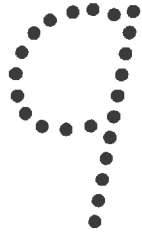
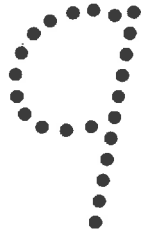
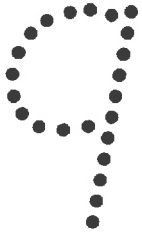
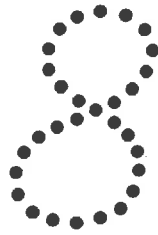
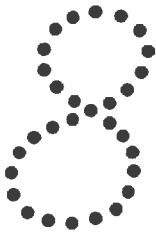
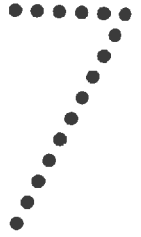
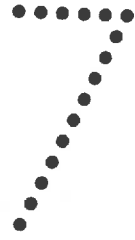
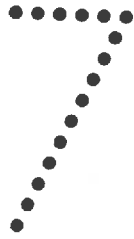
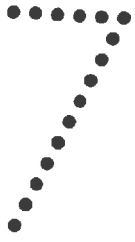

Shape Tracing

Trace the shapes below.

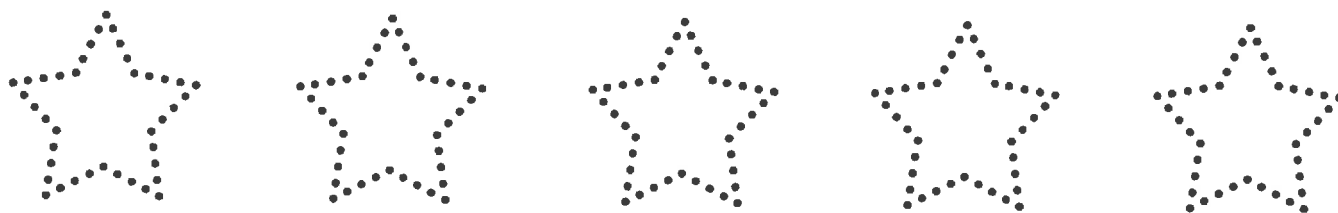
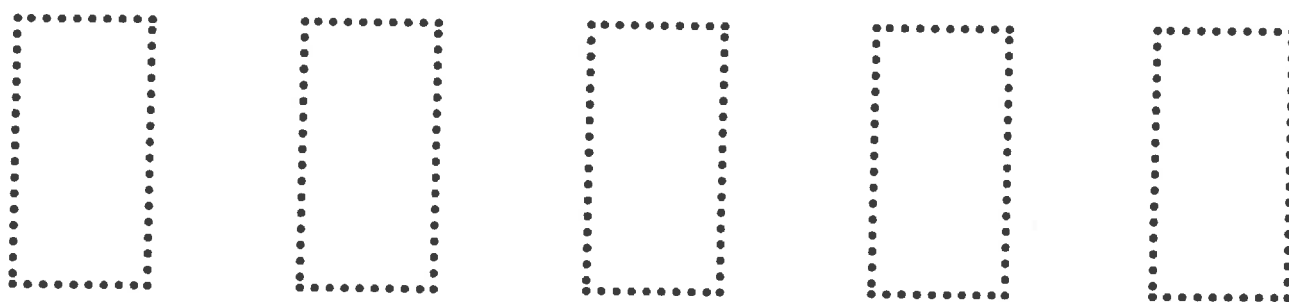
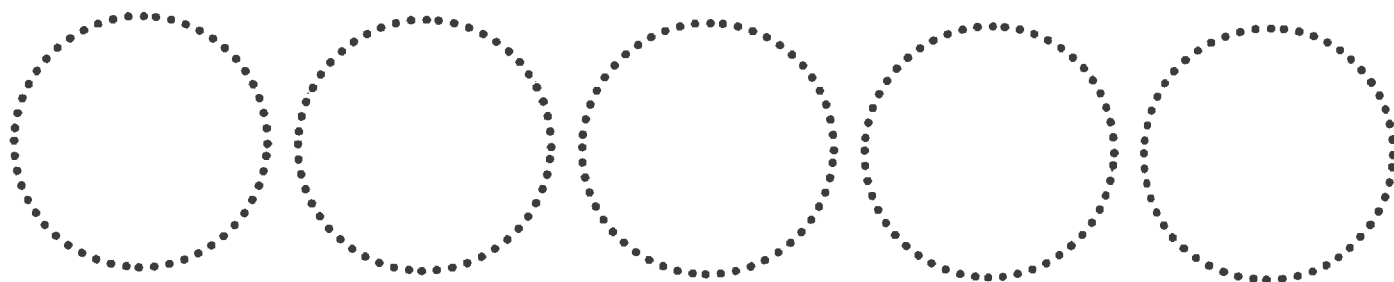
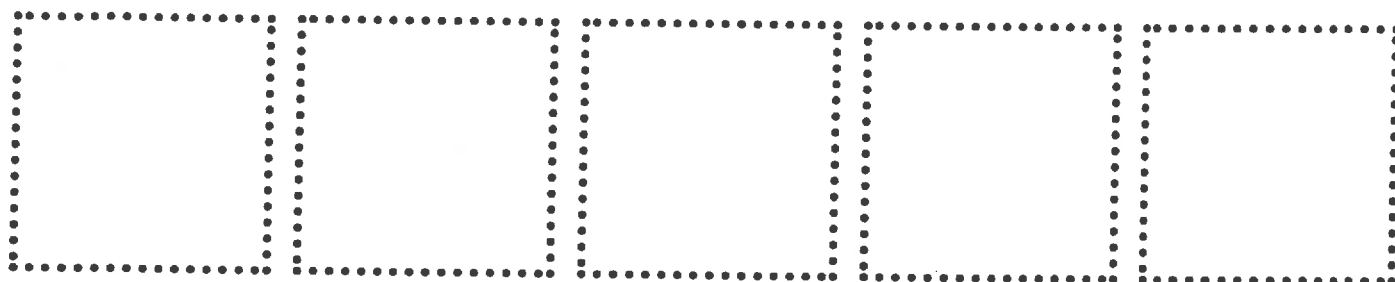

This

and That

Name: _____

Copyright © 2012 Maria Manore

www.kindercraze.blogspot.com

I went
on a Trip

Name: _____

Copyright © 2012 Maria Manore

www.kindercraze.blogspot.com

“and” Sight Word Reader

Students will cut out each letter, unscramble, and glue into the “And” book

a a n

d n a

n a a

d n a

a d n

t w e n

e n w t

w t n e

n t e w

n w e t

“I Went on a Trip” Sight Word Reader
Students will cut out each letter, unscramble, and glue into the “I Went on a Trip” book

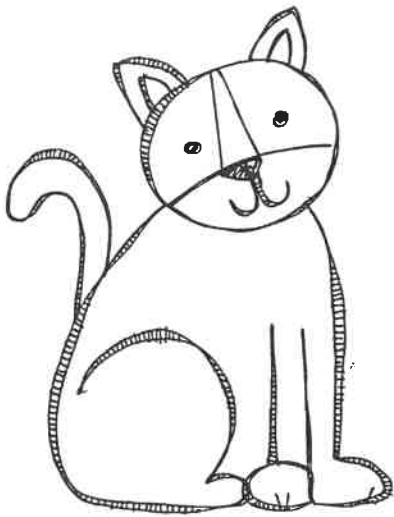

cat

--	--	--

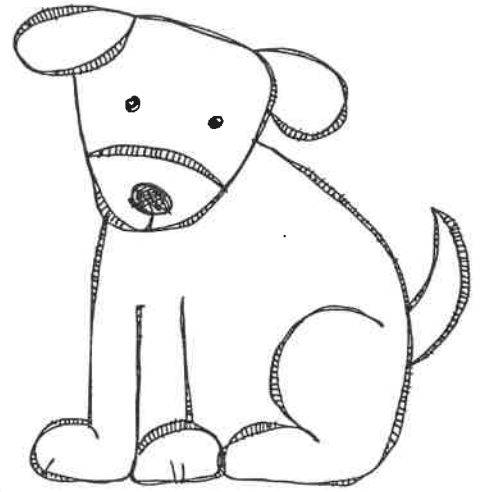

dog

3

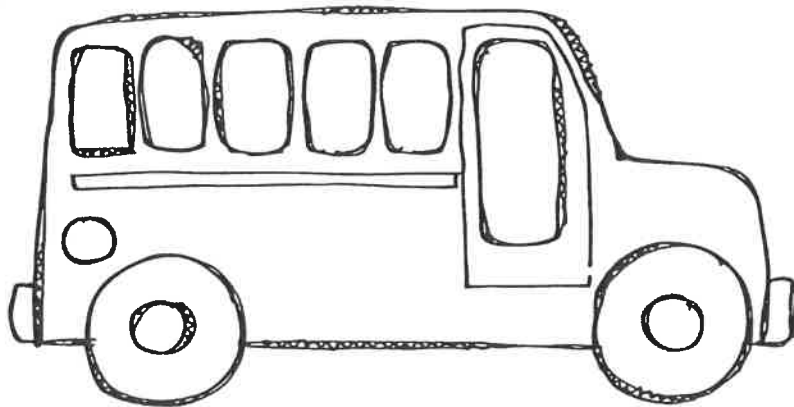

I

--	--	--	--

in a bus.

3

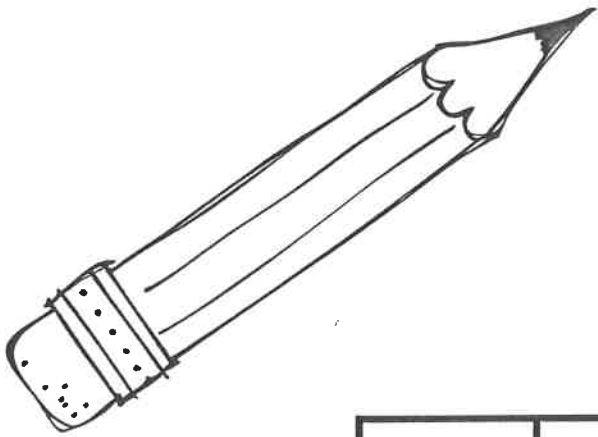

pencil

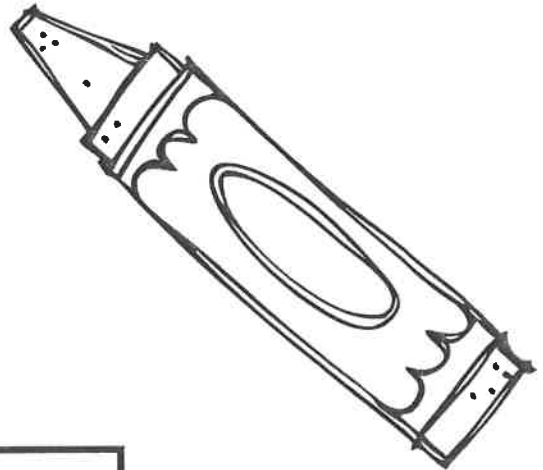

crayon

--	--	--

2

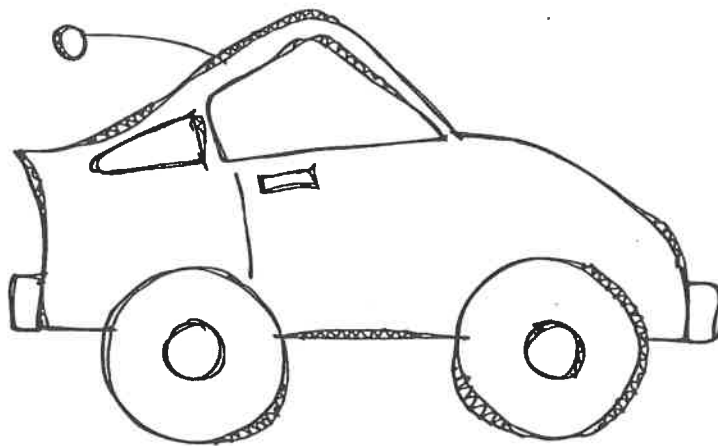

I

--	--	--	--

in a car.

2



Black

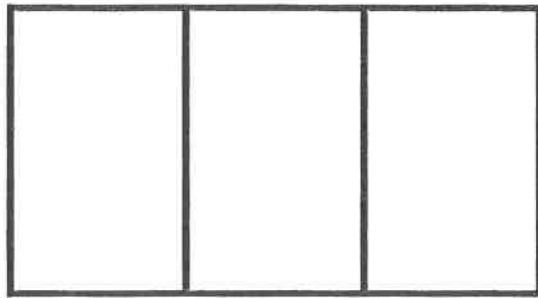

white!

6

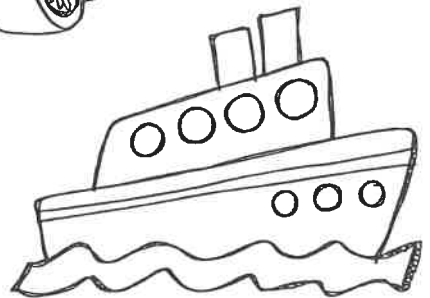
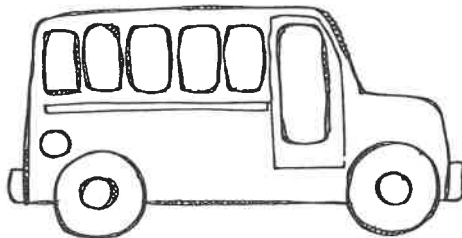
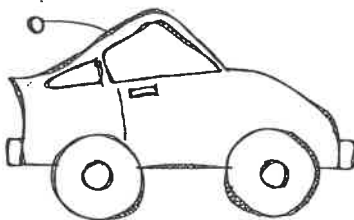
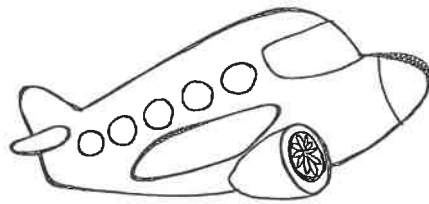

I

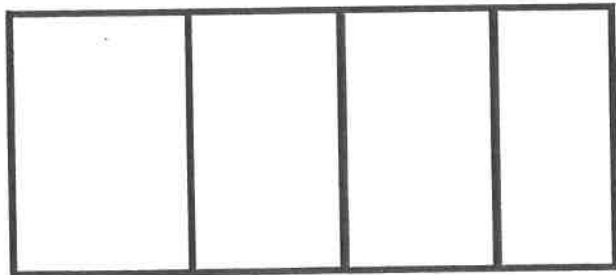

on a trip!

6



King

--	--	--

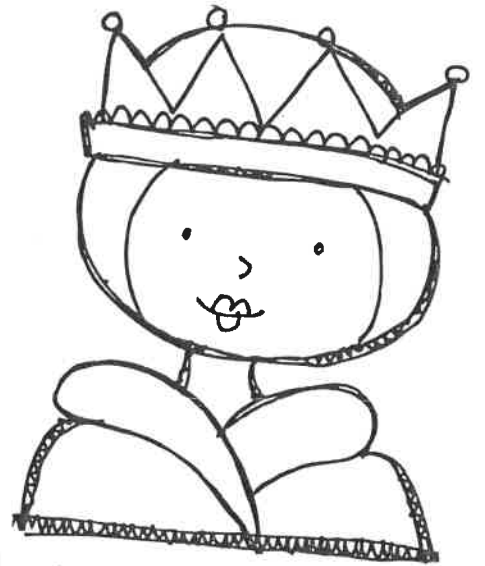

queen

5

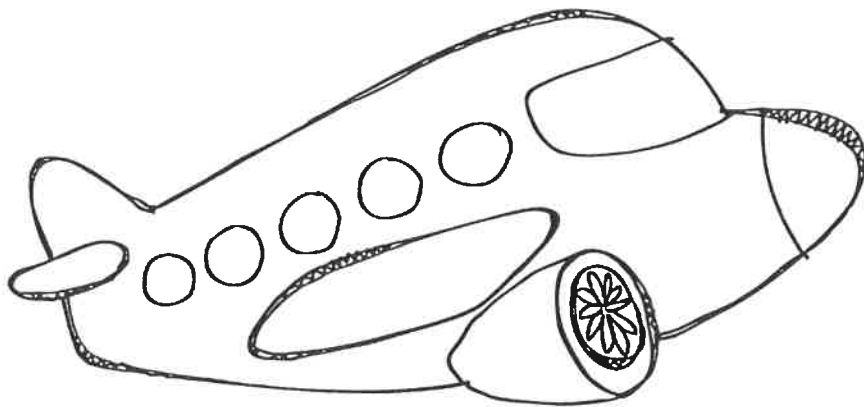

I

--	--	--	--

in a plane.

5

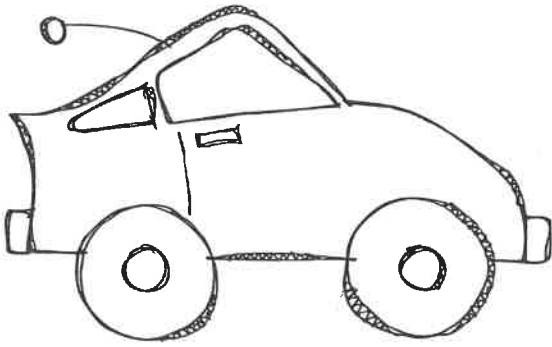

car

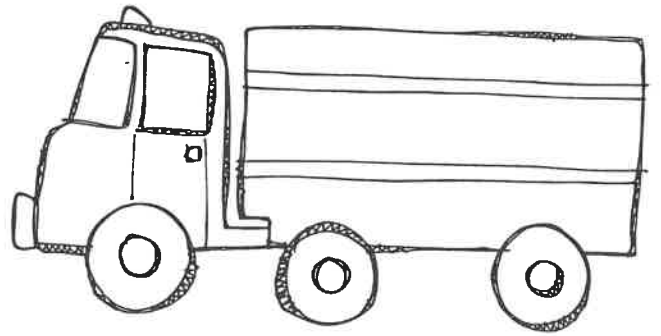

truck

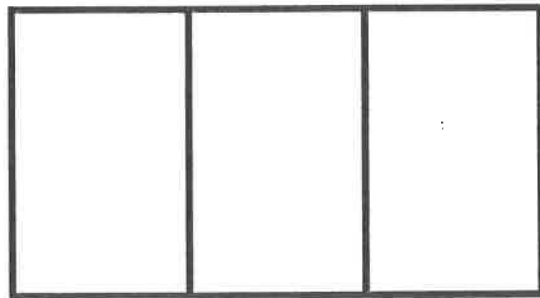

4

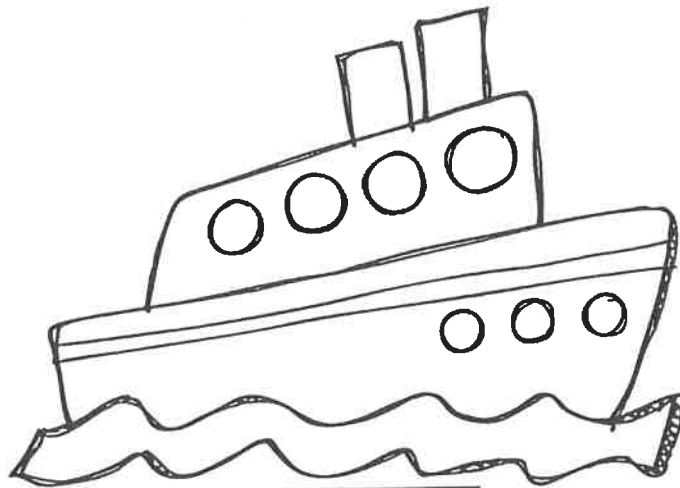

I

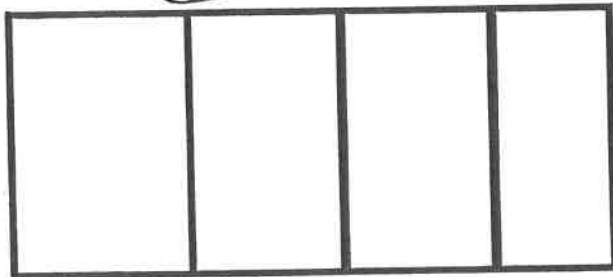

in a boat.

4

DINNER DIARY

Write down and draw everything you had for dinner.

What was your favourite part?

What is your favourite vegetable?

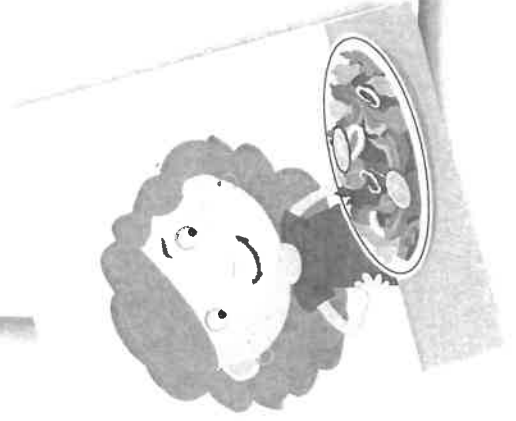

DINNER DIARY

Handwriting practice lines consisting of ten horizontal dashed lines.

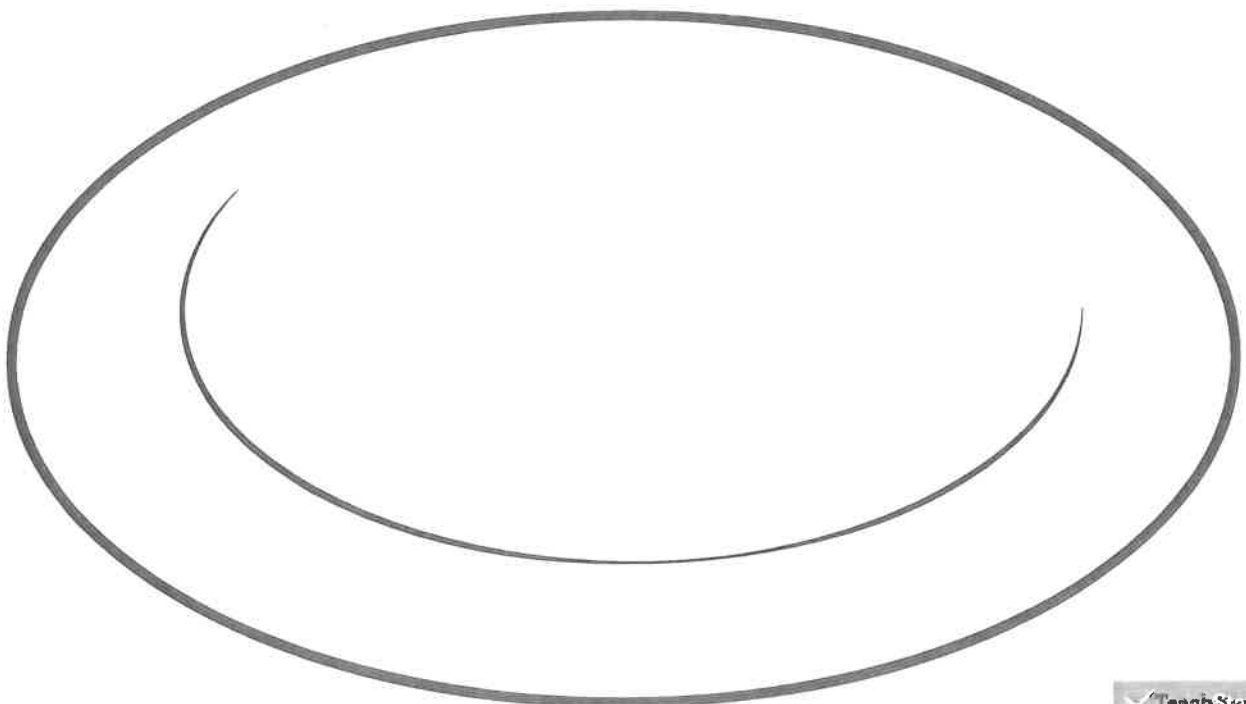

FAMILY FILES

Write a short story using all of the people who live with you as the main characters. Illustrate your story.



FAMILY FILES

Handwriting practice area consisting of seven sets of horizontal dashed lines for writing.

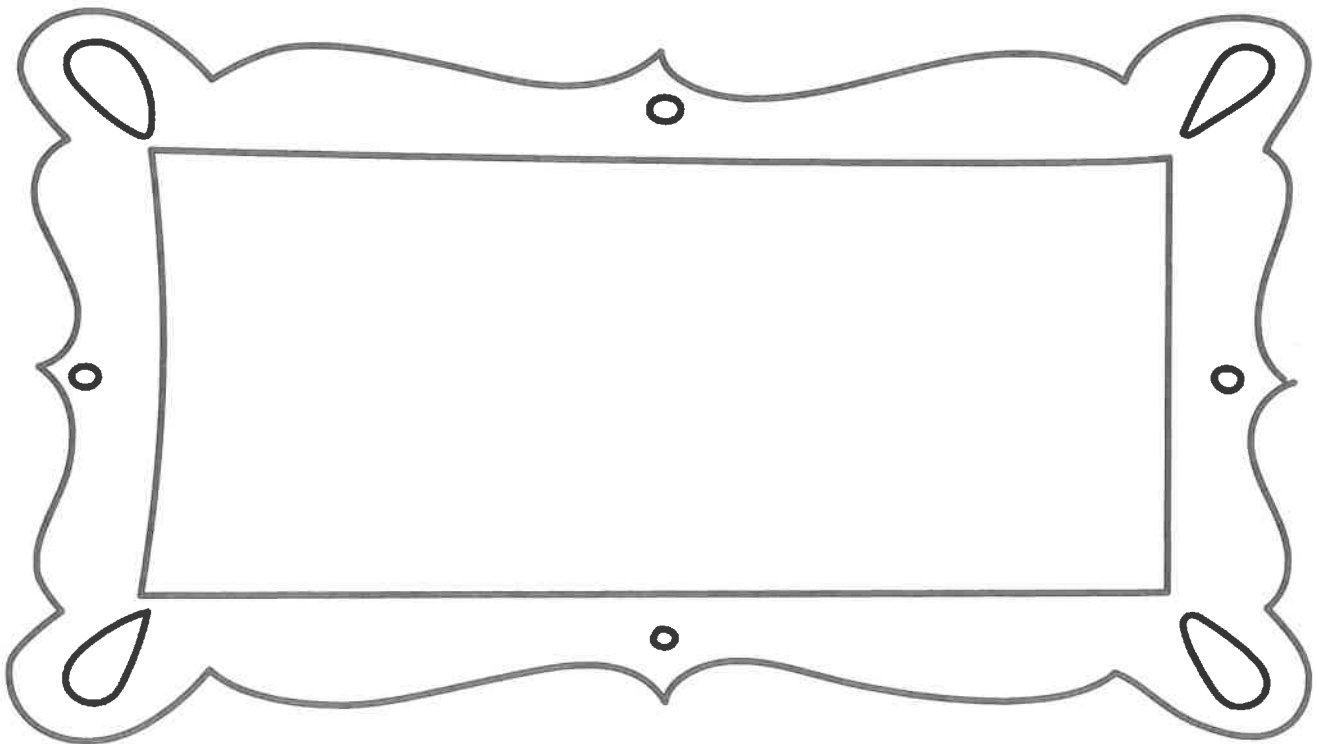

OUTSIDE PLAY

Describe something that happened to you or something you saw when you were outside today. Did you see an interesting animal when you were out and about? Was there a particular car or bus that caught your attention?



OUTSIDE PLAY

A series of ten horizontal dashed lines for handwriting practice.

YOUR DAY

Make a list of all the things that you did throughout the day - right up until you brush your teeth and go to bed. Don't forget to add in anytime you spent playing and any snacks you had throughout the day.

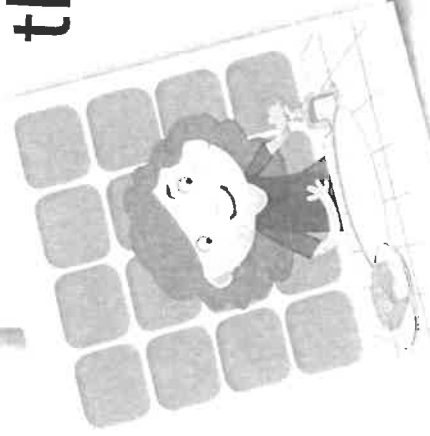

YOUR DAY

A series of ten horizontal dashed lines for writing.

All About Me

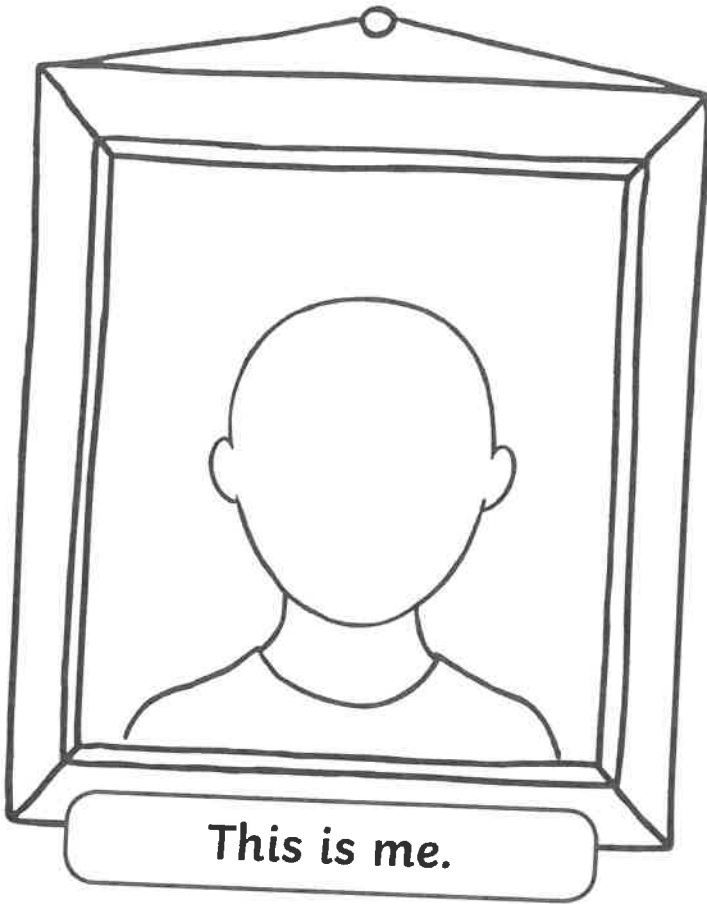

My name is:

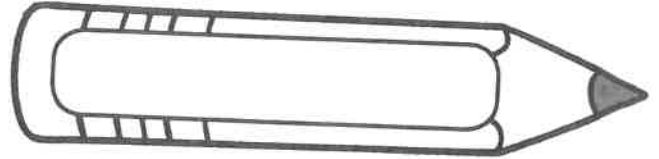

My birthday is:

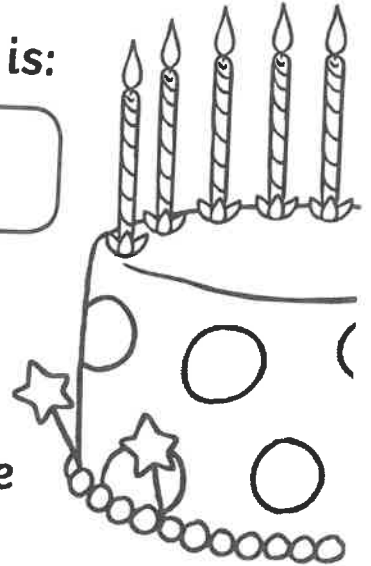

My favourite food is:

My favourite colour is:

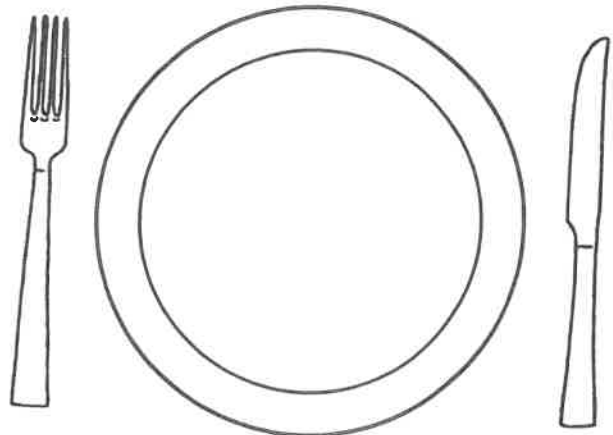
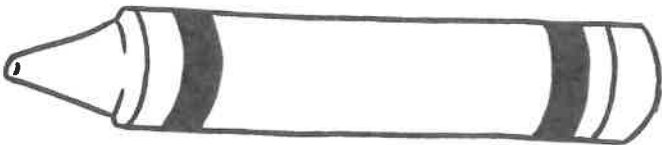

My favourite book is:

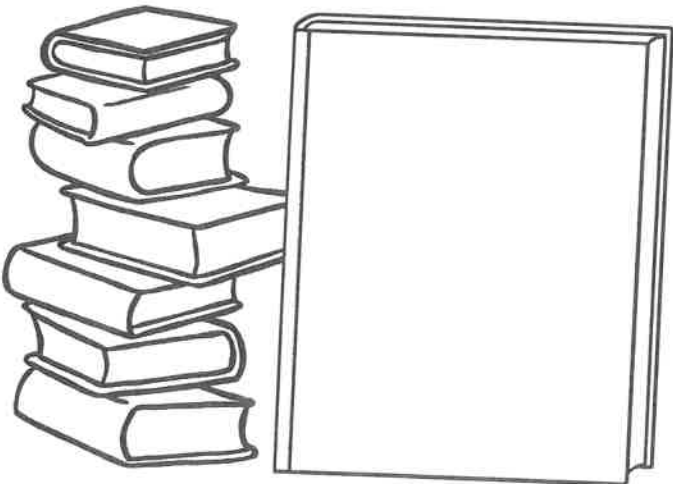

My favourite television show is:



Family Homework Grid

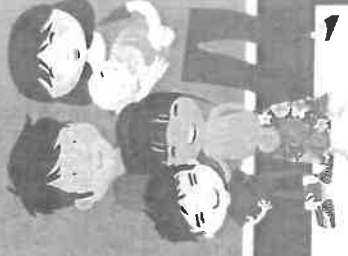

Help set the table for dinner each night.	Go on a picnic with your family.	Write a silly story together as a family	Go on a nature walk and count how many birds and insects you find.	Cook a yummy treat with an older family member.
Read a story to a family member.	Help clean up after dinner each night.	Go for a bike ride as a family.	Help put the clean dishes away.	Draw a family tree.
Find out who your great grandparents were.	Ask an older family member what games they played as a child.	Help put out the washing once a week.	Video call a family member you haven't seen in a while.	Create a family portrait.
Make an indoors or outdoors cubby house with your family.	As a family gather some unused household items and donate them to charity.	Write a letter to a family member telling them how much they mean to you.	Make your own bed for a whole week.	Play a board game with your family.

My Five Senses Scavenger Hunt

Something smooth

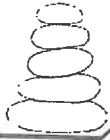

Something rough

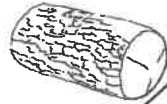

Something that makes a noise



Something round



Something yellow



Something that came from a plant



Something that has a smell



Something long



Something man-made



Something soft



Something you can eat











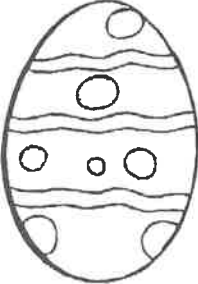

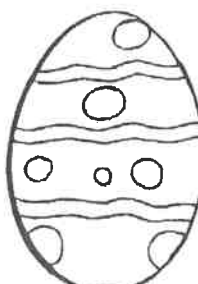
Something red

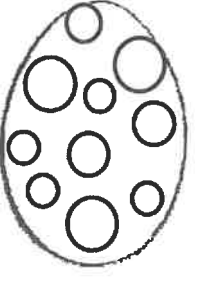
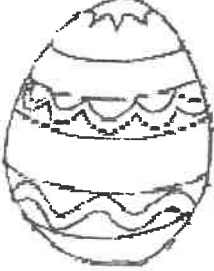
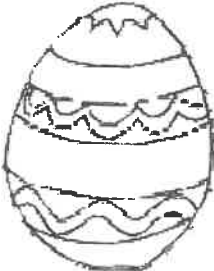
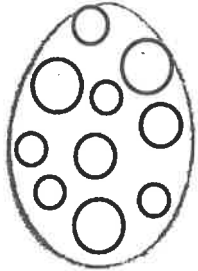
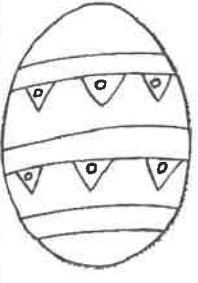
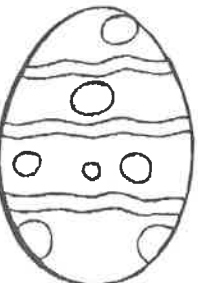

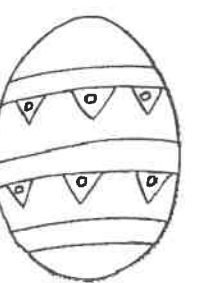
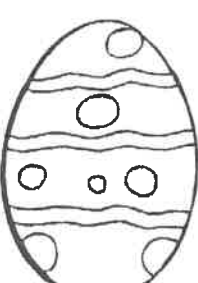
Easter Egg Patterns

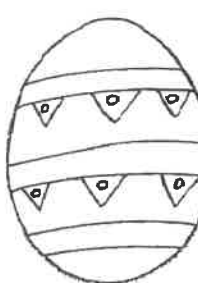
© TeachThis.com.au (2009)

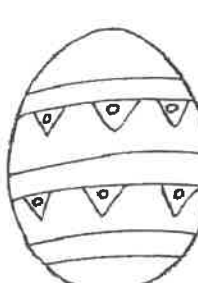
Use each of these eggs to finish the patterns.

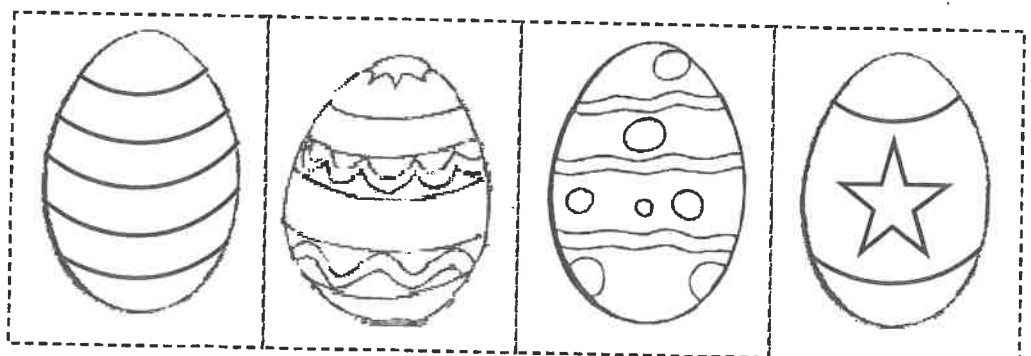

Which has more?

Name: _____

1. Count and write the number of smarties below each cookie.
2. Colour the cookie in each pair that has the most smarties.

Teach  FIRST

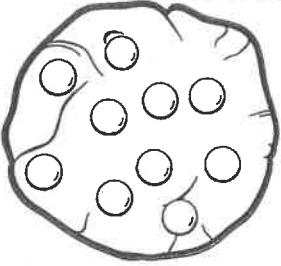
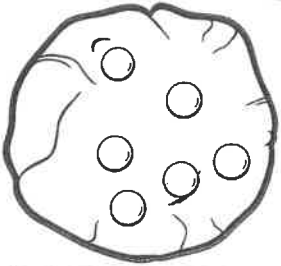
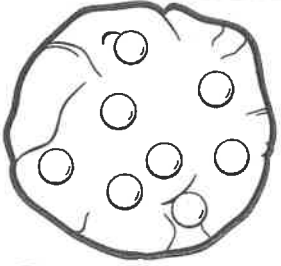
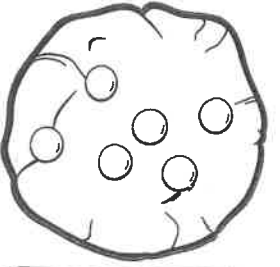
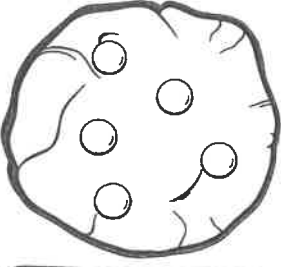
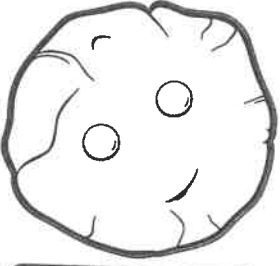
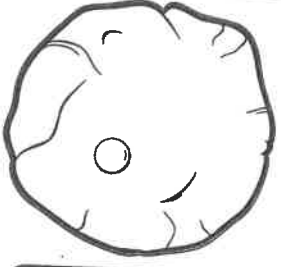
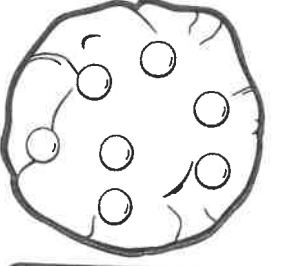
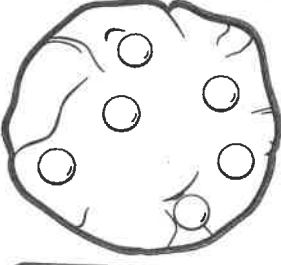
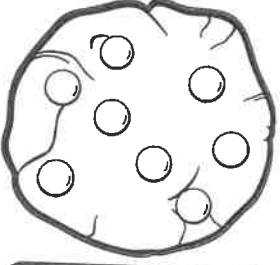
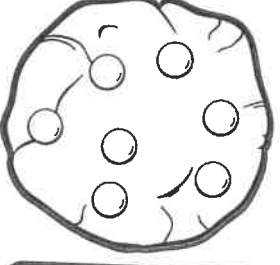
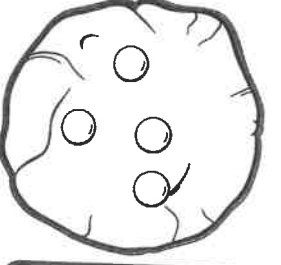
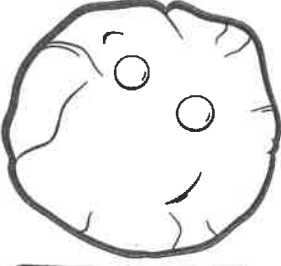
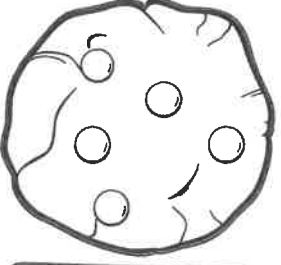
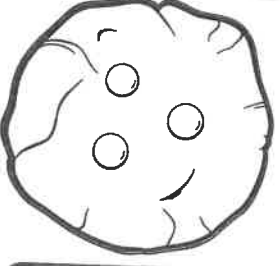
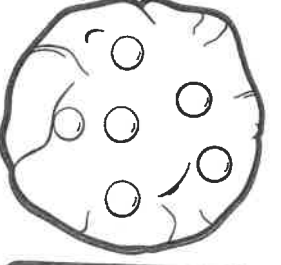
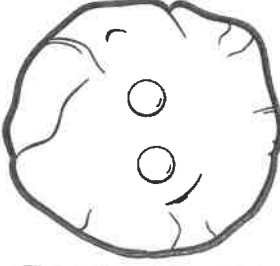
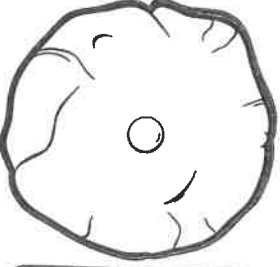
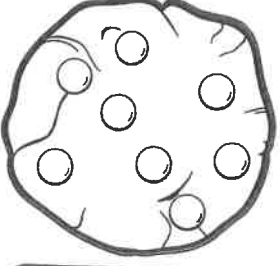
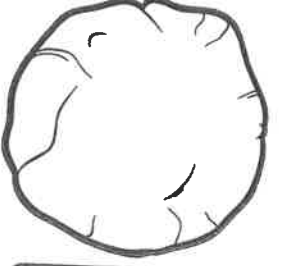

 <input type="text"/>	 <input type="text"/>	 <input type="text"/>	 <input type="text"/>
 <input type="text"/>	 <input type="text"/>	 <input type="text"/>	 <input type="text"/>
 <input type="text"/>	 <input type="text"/>	 <input type="text"/>	 <input type="text"/>
 <input type="text"/>	 <input type="text"/>	 <input type="text"/>	 <input type="text"/>
 <input type="text"/>	 <input type="text"/>	 <input type="text"/>	 <input type="text"/>

Which has more?

Name: _____

1. Count and write the number of jellybeans in each jar.
2. Colour the jellybeans in each pair that has the most.

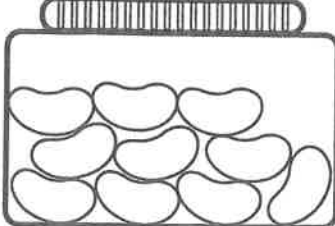
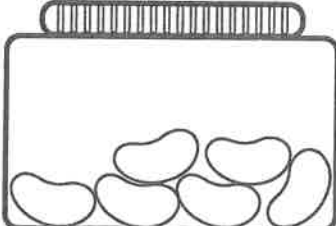
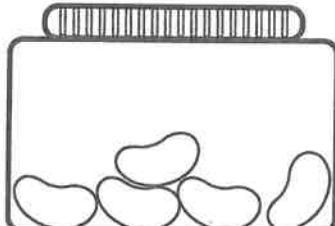
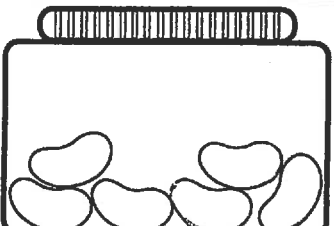
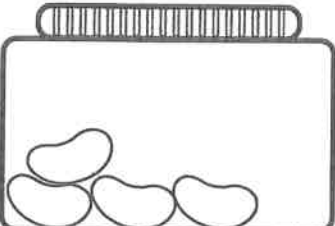
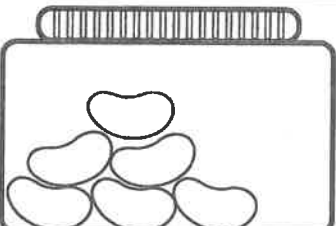
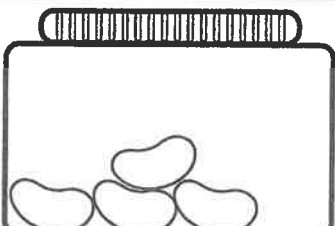
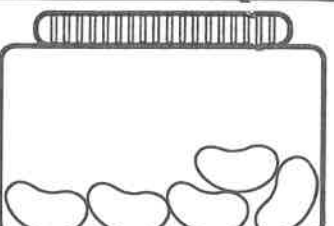
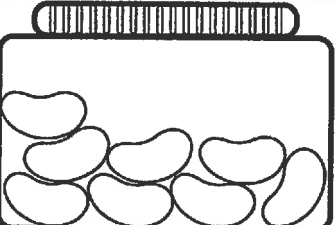
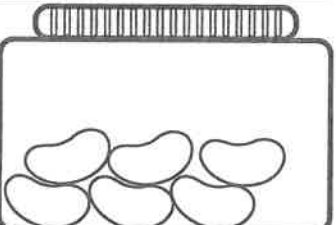
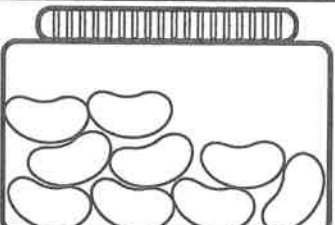
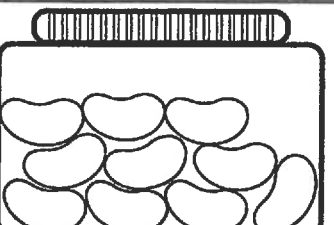
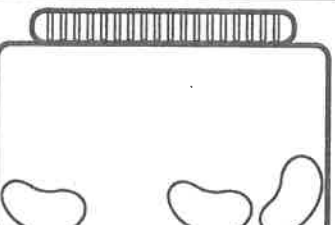
Teach 

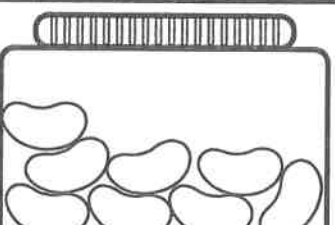
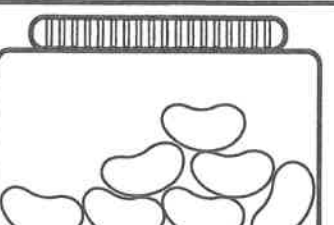
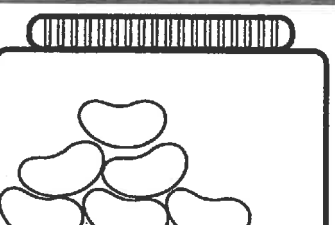
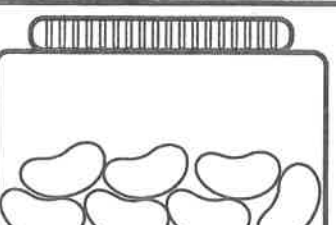
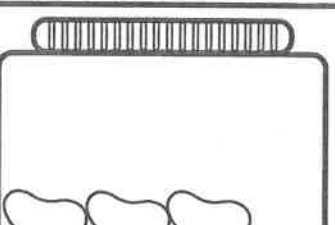
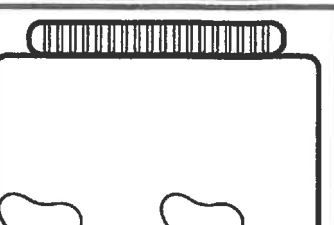
 <input data-bbox="103 627 391 728" type="text"/>	 <input data-bbox="462 627 750 728" type="text"/>	 <input data-bbox="837 627 1125 728" type="text"/>	 <input data-bbox="1197 627 1484 728" type="text"/>
 <input data-bbox="103 985 391 1086" type="text"/>	 <input data-bbox="462 985 750 1086" type="text"/>	 <input data-bbox="837 985 1125 1086" type="text"/>	 <input data-bbox="1197 985 1484 1086" type="text"/>
 <input data-bbox="103 1344 391 1444" type="text"/>	 <input data-bbox="462 1344 750 1444" type="text"/>	 <input data-bbox="837 1344 1125 1444" type="text"/>	 <input data-bbox="1197 1344 1484 1444" type="text"/>
 <input data-bbox="103 1702 391 1803" type="text"/>	 <input data-bbox="462 1702 750 1803" type="text"/>	 <input data-bbox="837 1702 1125 1803" type="text"/>	 <input data-bbox="1197 1702 1484 1803" type="text"/>
 <input data-bbox="103 2060 391 2161" type="text"/>	 <input data-bbox="462 2060 750 2161" type="text"/>	 <input data-bbox="837 2060 1125 2161" type="text"/>	 <input data-bbox="1197 2060 1484 2161" type="text"/>











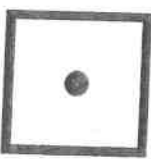



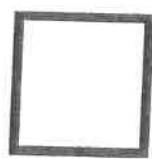

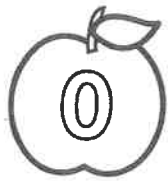

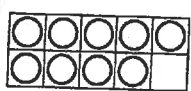



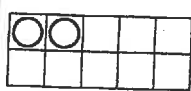
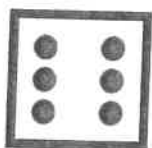

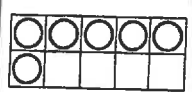
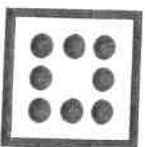
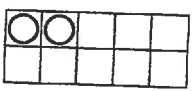
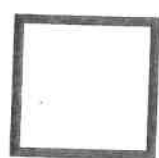
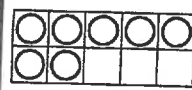
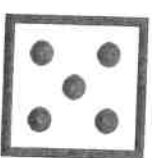



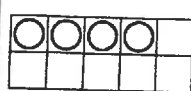



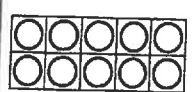
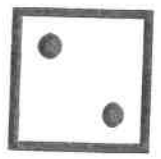
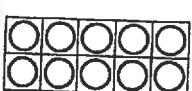

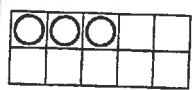
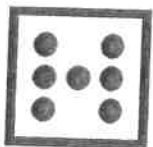

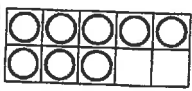
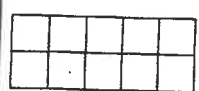
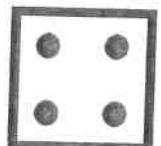

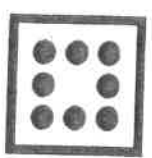
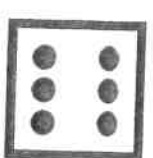
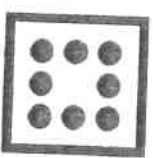

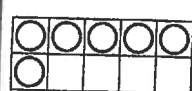
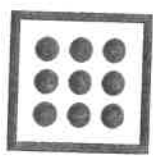
The Amazing Maze

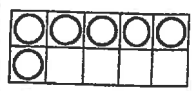

Help the unicorn to find his way to the rainbow.

Teach **THIS**

Colour all the spaces that have the value 1, 3, 5, 7 or 9.

 start						
						
						
						
						
						
						
						
						finish 

Roll a Number Dice Net

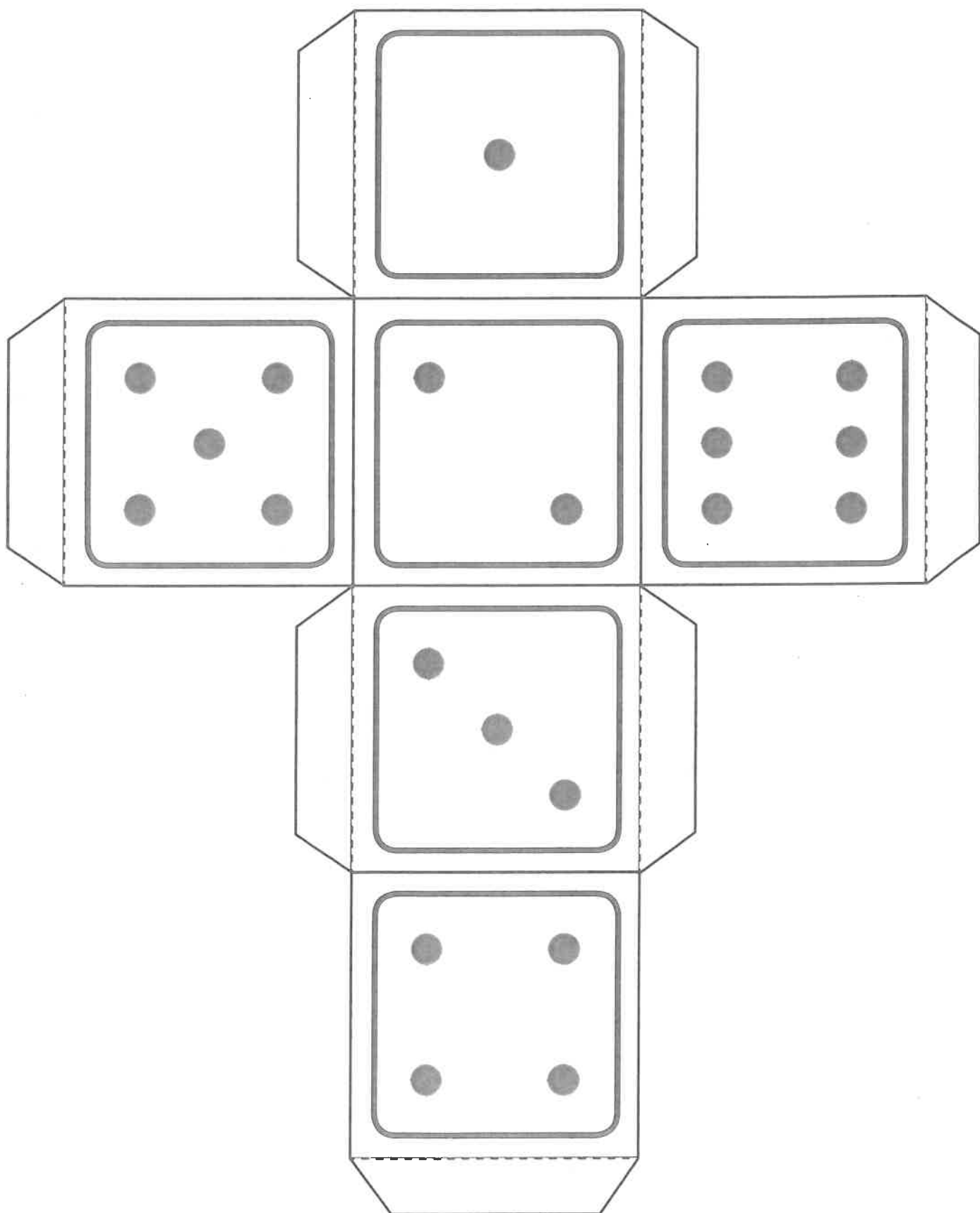

Roll a Number

Roll the dice and write the matching number in the correct column.

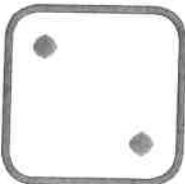
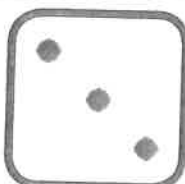
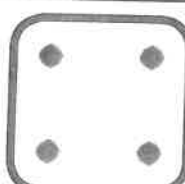
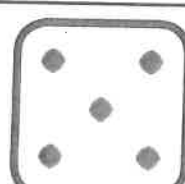
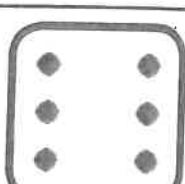
1	2	3	4	5	6
1	2	3	4	5	6
1	2	3	4	5	6
					
one	two	three	four	five	six

1 one



1 one



Tracing practice line with arrows and numbers 1-10.

one

2 two



2 two

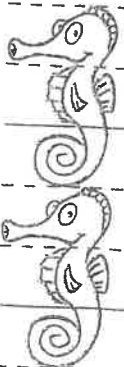

Tracing practice line with arrows and numbers 1-10.

two

3 three :: 3 three

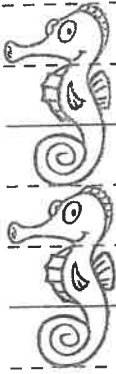

three

4 four :: 4 four

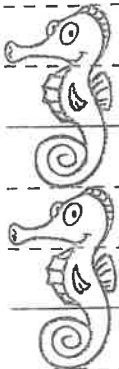

four

5 five

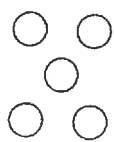

5 five

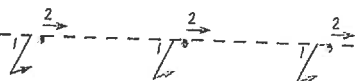
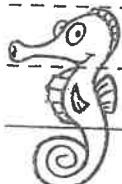

five

6 six

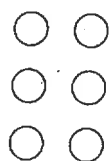

6 six

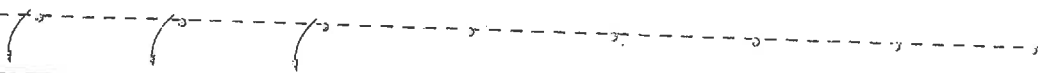

six

7 seven :: 7 seven

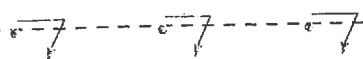

seven

8 eight :: 8 eight

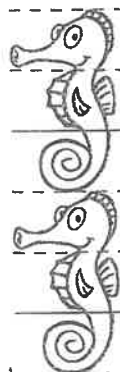

eight

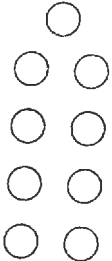
9 nine  9 nine



9

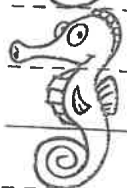

nine

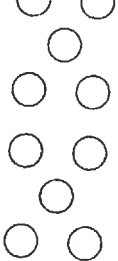
10 ten  10 ten



10



ten

TIME WILL TELL

Time yourself doing things around the house such as brushing your teeth, eating dinner, putting your shoes on, making your bed or any other things you would normally do.

Put your activities in order from the one you did the quickest to the slowest.

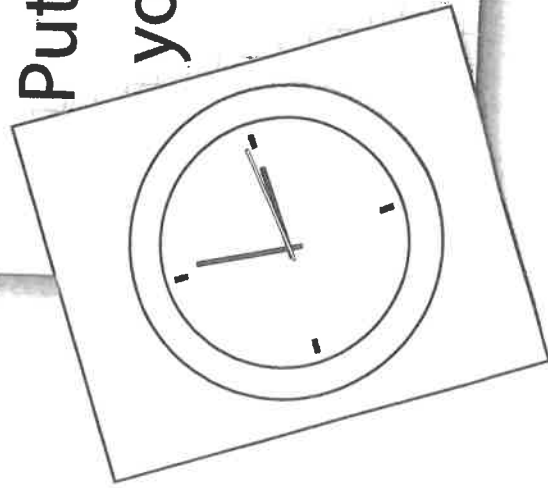

TIME WILL TELL

Activity	Time
Brushing your teeth	
Eating dinner	
Putting your shoes on	
Making your bed	

List your activities in order from quickest to slowest.

SHAPES EVERYWHERE

Find different objects in your bedroom that are 2D shapes.

Draw the objects you found and write what shapes they are.

Some 2D shapes you could find include squares, rectangles, triangles, circles and hexagons.

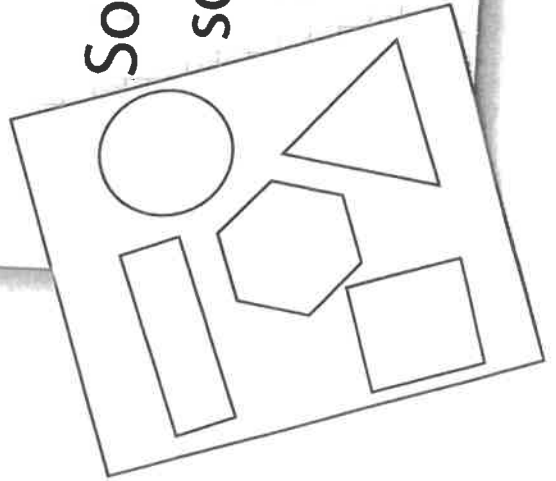

SHAPES EVERYWHERE

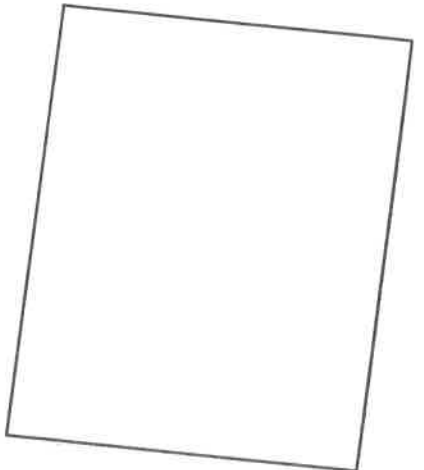
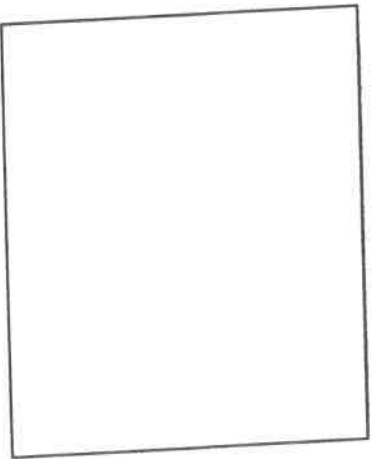
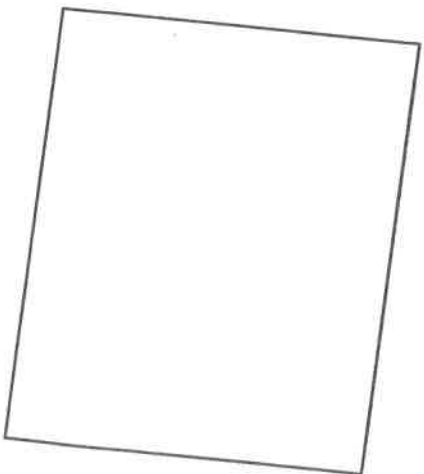
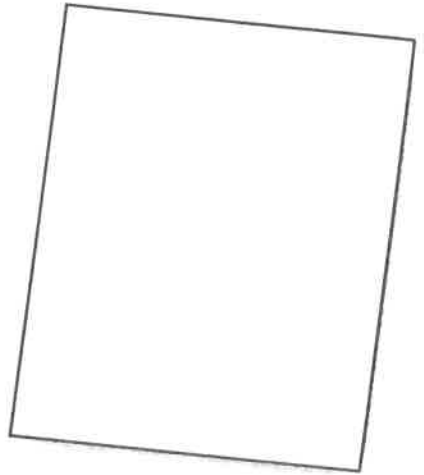
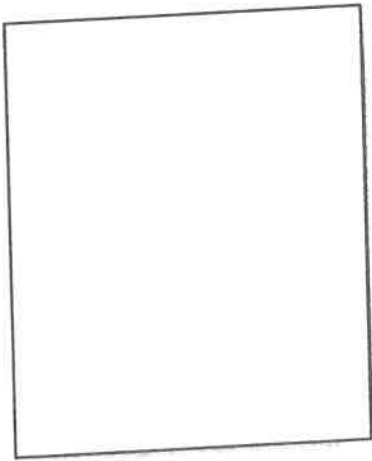
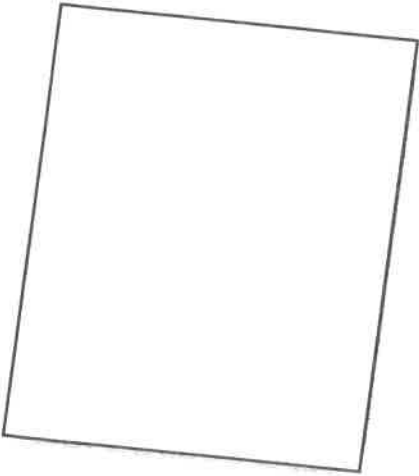
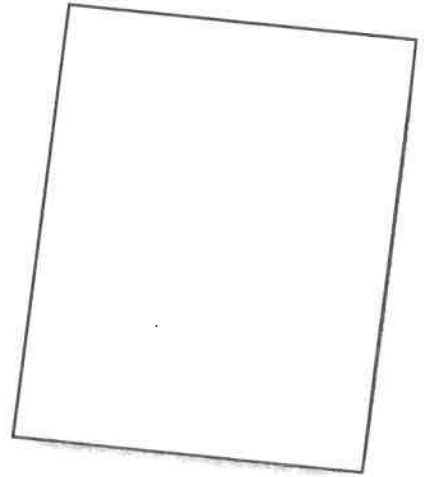
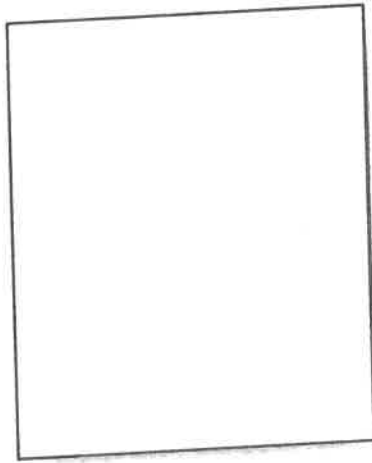
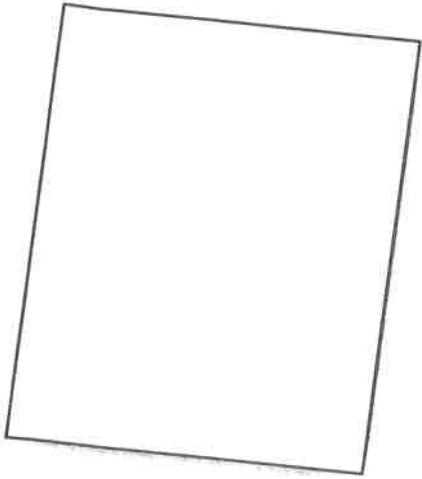

MAP MAKER

Draw a map of your bedroom as if you were looking at it from above. Label each of your pieces of furniture and all of the things in your room.

Try to draw the things in your bedroom to scale, which means that if your bed is the biggest piece of furniture in your room, then it should be the biggest piece of furniture on your map.

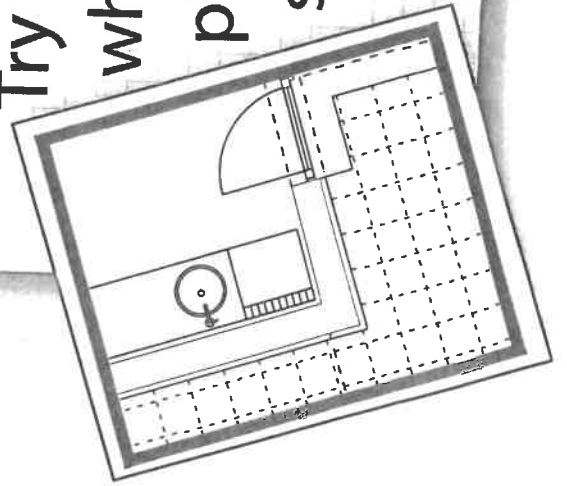

MAP MAKER

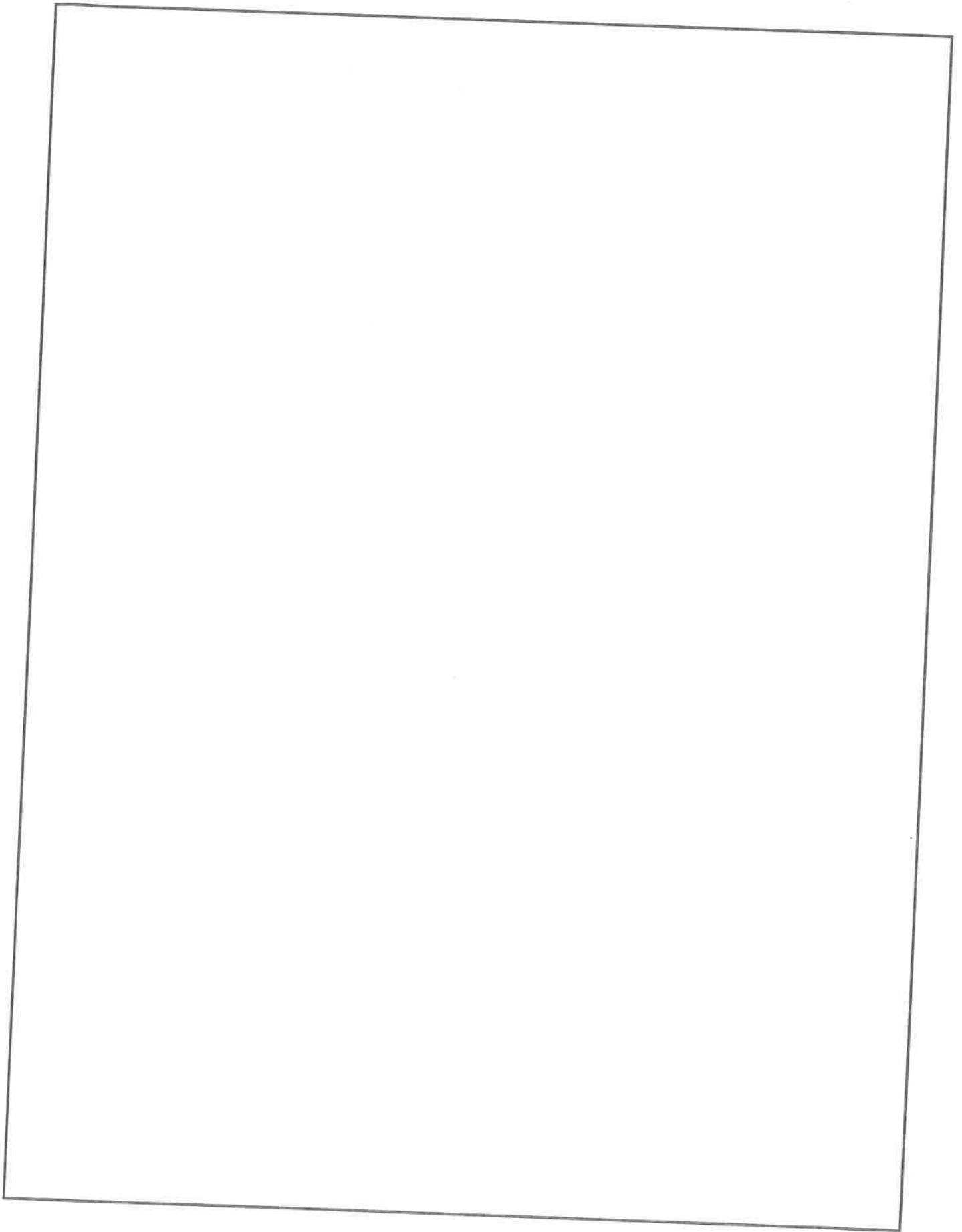

FOOD FUN

Look at all of the pieces of fruit or vegetables in your house.

Put them in order from the largest to the smallest and draw a picture of them.

Label each piece of food.

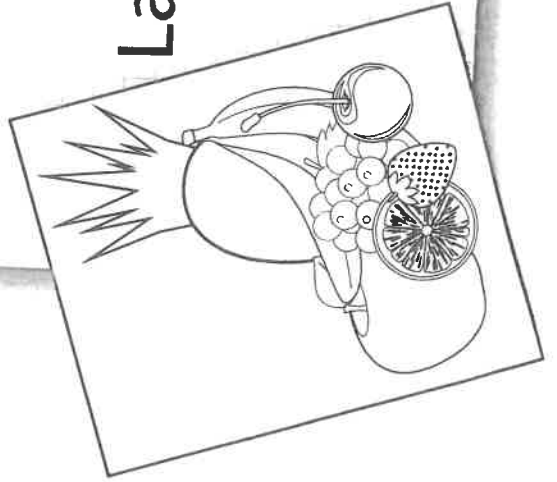

FOOD FUN

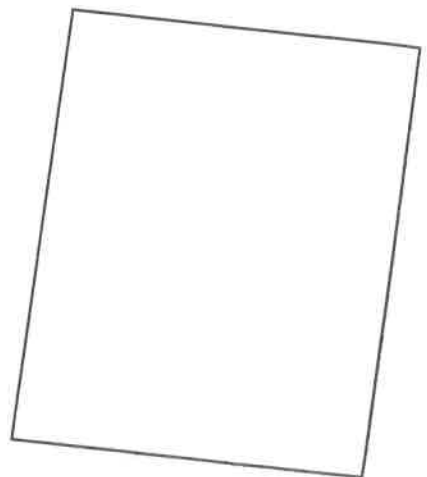
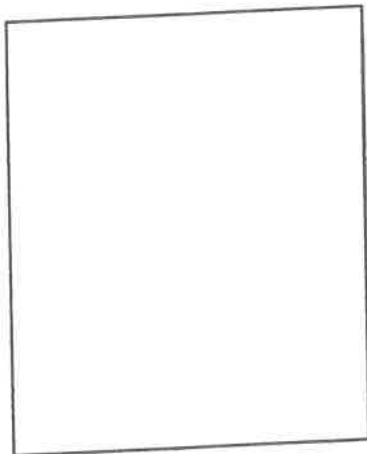
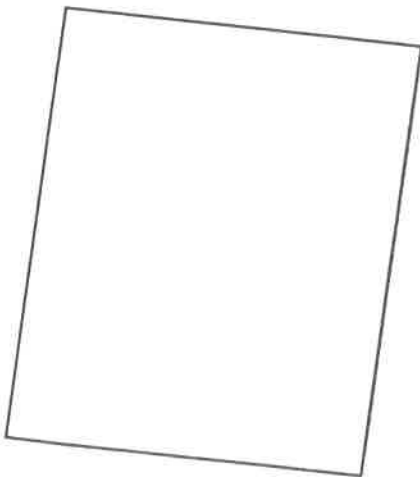
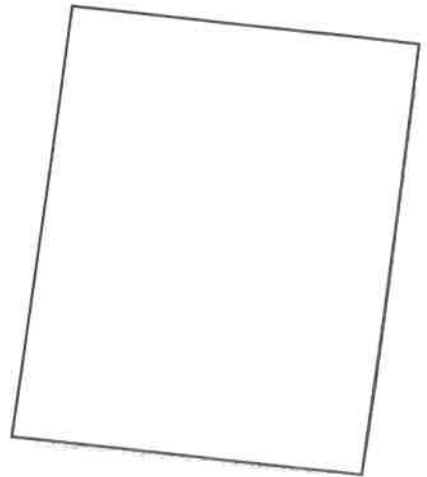
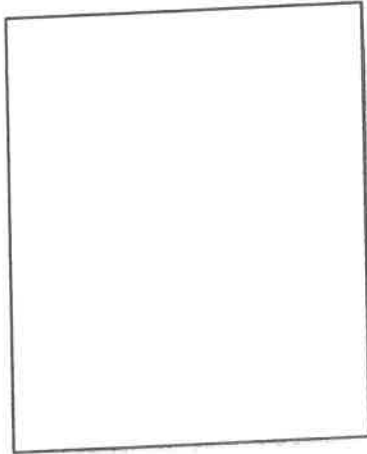
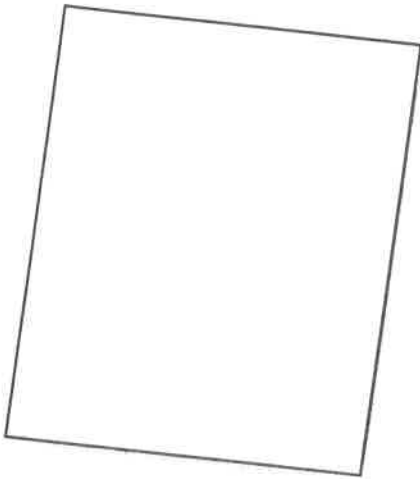
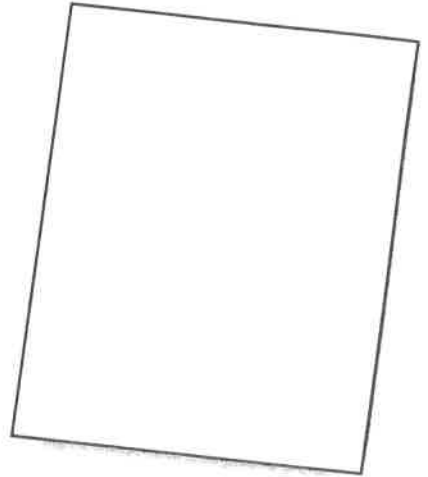
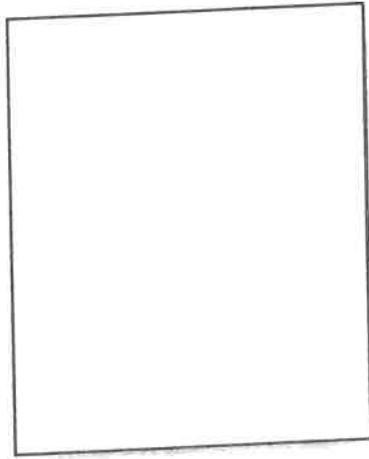
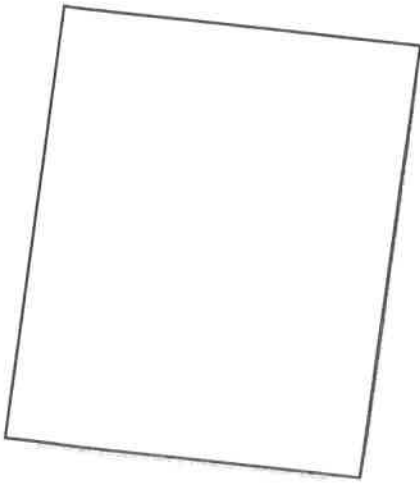

WHAT WEIGHT?

Pick 5 cans out of the cupboard.

Write the weight of each can down.

Draw the label of the heaviest can.

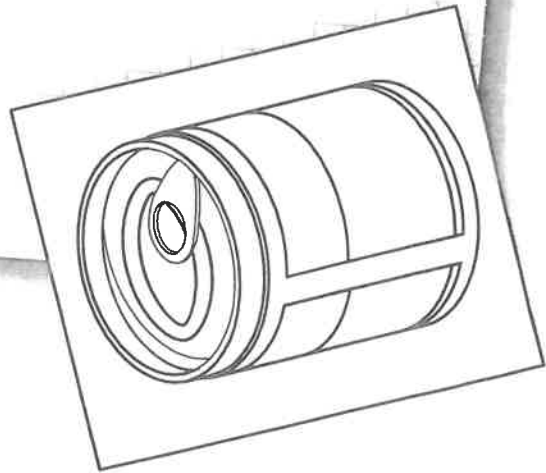

WHAT WEIGHT?



Can 1



Can 2



Can 3



Can 4



Can 5

Draw the label of the heaviest can.

ROOM SIZES

Pick three rooms in your house. Using your feet, measure around the walls to find out how big each room is.

Order your rooms from smallest to largest.

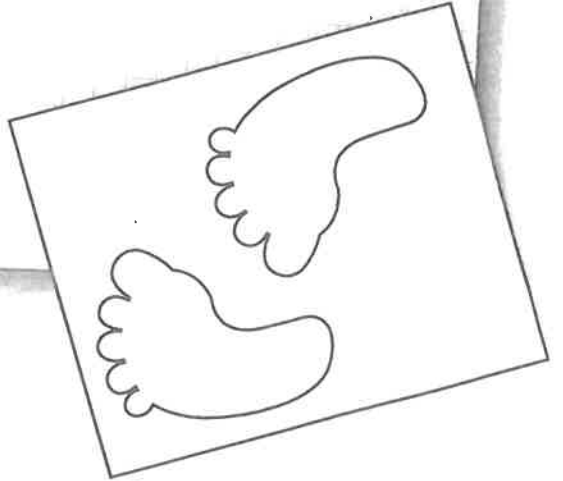

ROOM SIZES

Room 1

.....

side 1.....
side 2.....
side 3.....
side 4.....

Room 2

.....

side 1.....
side 2.....
side 3.....
side 4.....

Room 3

.....

side 1.....
side 2.....
side 3.....
side 4.....

List your rooms in order from smallest to largest.

.....

.....

.....

HOW MANY HANDLES?

Go from room to room counting how many handles there are in your house. Include handles on cupboards, doors, windows, drawers - anywhere you see a handle!

Which room has the most handles?

Do you have more handles on doors or more on drawers?

How many of your handles have locks?

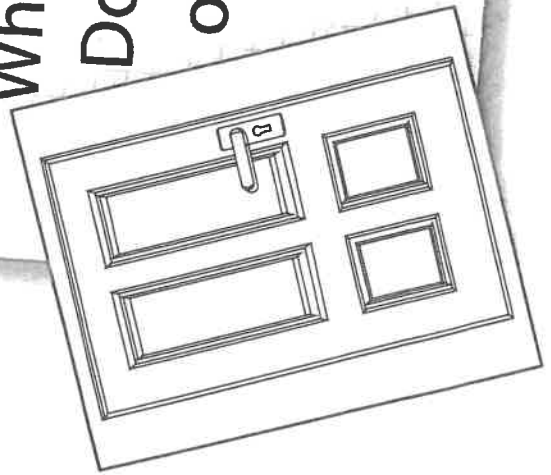

NUMBER PLATE MATHS

Go for a walk with an adult and find some number plates in your area.

- Put the numbers on each number plate in order from smallest to largest.
- Put the letters on each number plate in alphabetical order.
- Add the numbers on each number plate together.
- Keep a record of each number and letter you see. Put a tally mark next to each letter or number when you see it. Which number and letter did you see the most?
- Put them in order from the most to the least number of times you saw it.

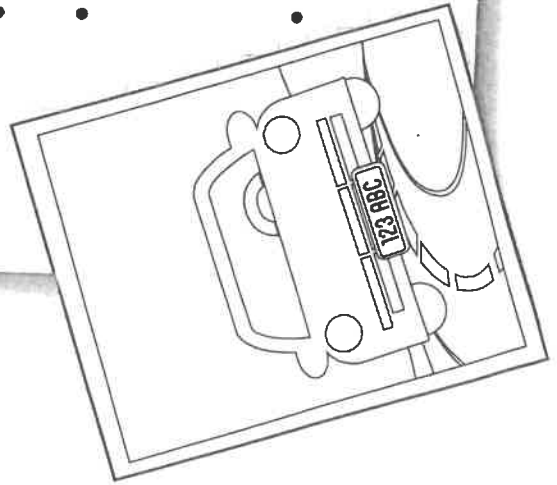

NUMBER PLATE MATHS

Which number did you see the most?

Which letter did you see the most?

Put the letters and numbers in order from the most to the least number of times you saw it.

Letters

Most

10 empty rectangular boxes for recording the frequency of letters.

Least

Numbers

Most

10 empty rectangular boxes for recording the frequency of numbers.

Least

NUMBER PLATE MATHS

Tally up how many times you saw each letter or number.

A	M	Y
B	N	Z
C	O	0
D	P	1
E	Q	2
F	R	3
G	S	4
H	T	5
I	U	6
J	V	7
K	W	8
L	X	9

NUMBER PLATE MATHS

Go for a walk with an adult and find some number plates in your area.

Arrange the numbers from smallest to largest on each number plate.

.....
.....
.....

Put the letters on each number plate in alphabetical order.

.....
.....
.....

MONEY MATTERS

Find a shopping receipt or catalogue at home.

- Pick 3 items you would like and work out how much it would cost to buy them all.
- Find 3 items you could buy for \$10.00.
- What are the cheapest and most expensive items?

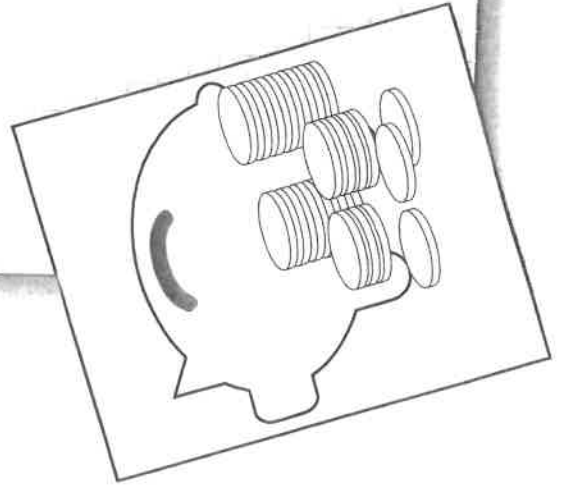

MONEY MATTERS

Pick 3 items you would like and work out how much it would cost to buy them all.

Item 1.....
Item 2.....
Item 3.....
.....
Total

Find 3 items you could buy for \$10.00.

Item 1.....
Item 2.....
Item 3.....
.....
Total

Draw the cheapest item.

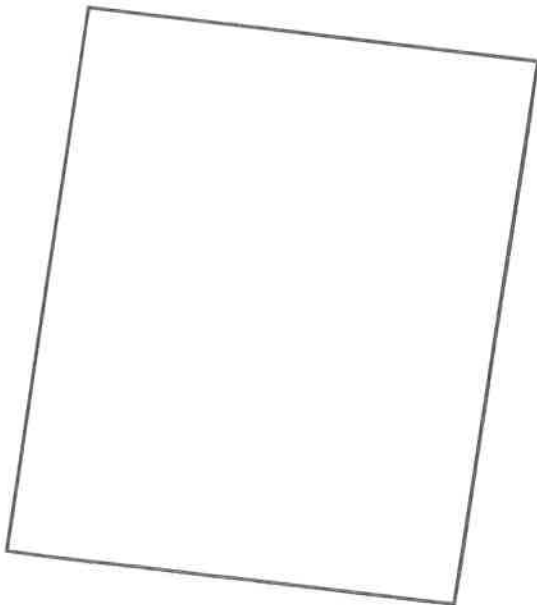

\$

.....

Draw the most expensive item.

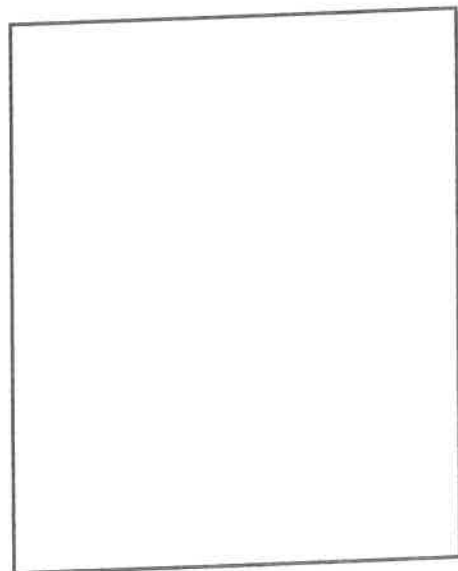

\$

.....

TV TIME

If you watch TV, keep a record throughout the week of when you watch TV and for how long.

At the end of the week, add up how long you watched TV for.

If you don't watch TV, you could use time spent reading, playing outside or doing chores.

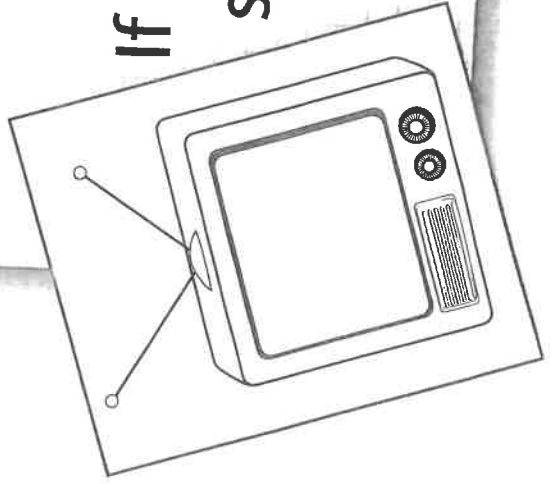

TV TIME

Day of the week	Time watching tv
Sunday	
Monday	
Tuesday	
Wednesday	
Thursday	
Friday	
Saturday	

Total time watching tv this week:

Star Number Bonds to 10

Write the missing number to make each star equal to 10.

6 +

8 +

10 +

2 +

5 +

9 +

1 +

3 +

7 +

4 +

0 +

Star Number Bonds to 10 Answers

Write the missing number to make each star equal to 10.

6 + 4

8 + 2

10 + 0

2 + 8

5 + 5

9 + 1

1 + 9

3 + 7

7 + 3

4 + 6

0 + 10

10

2D Shape Colouring

Can you colour the shapes to complete the picture?

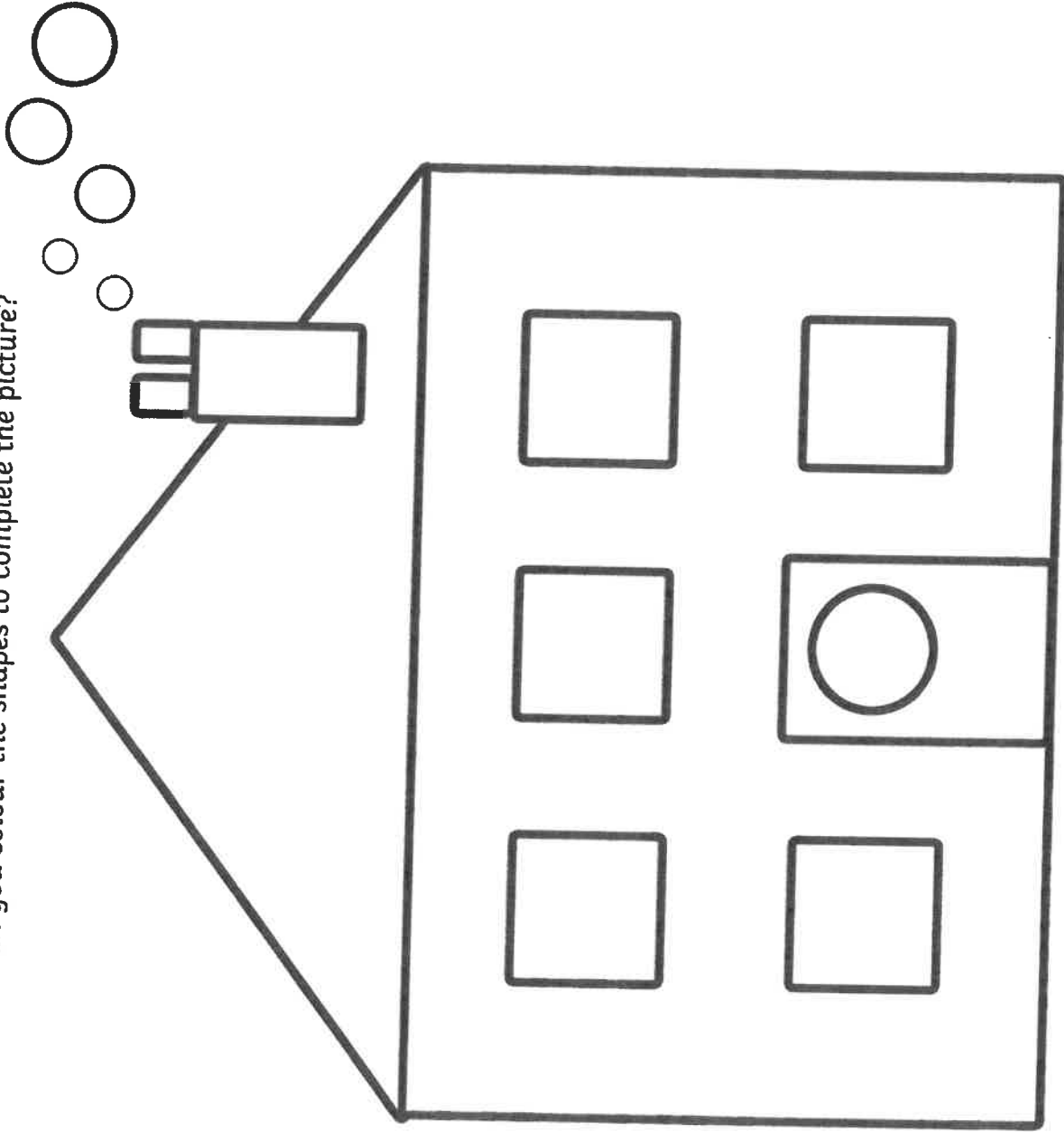

Key:



= red



= blue



= yellow



= green

2D Shape Colouring

Can you colour the shapes to complete the picture?

Key:

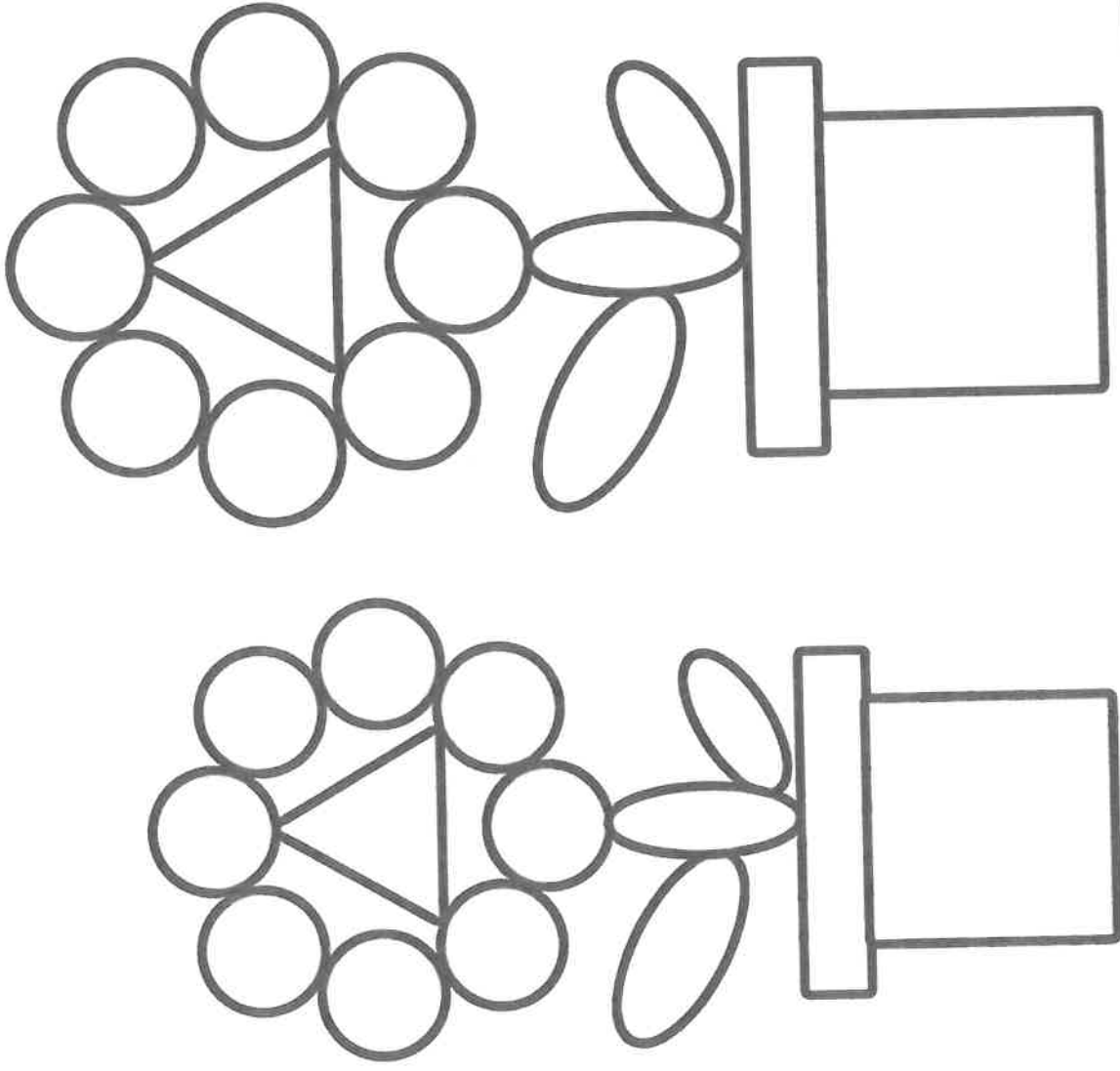

2D Shape Colouring

Can you colour the shapes to complete the picture?

Key:

○ = brown

□ = blue

△ = yellow

□ = green

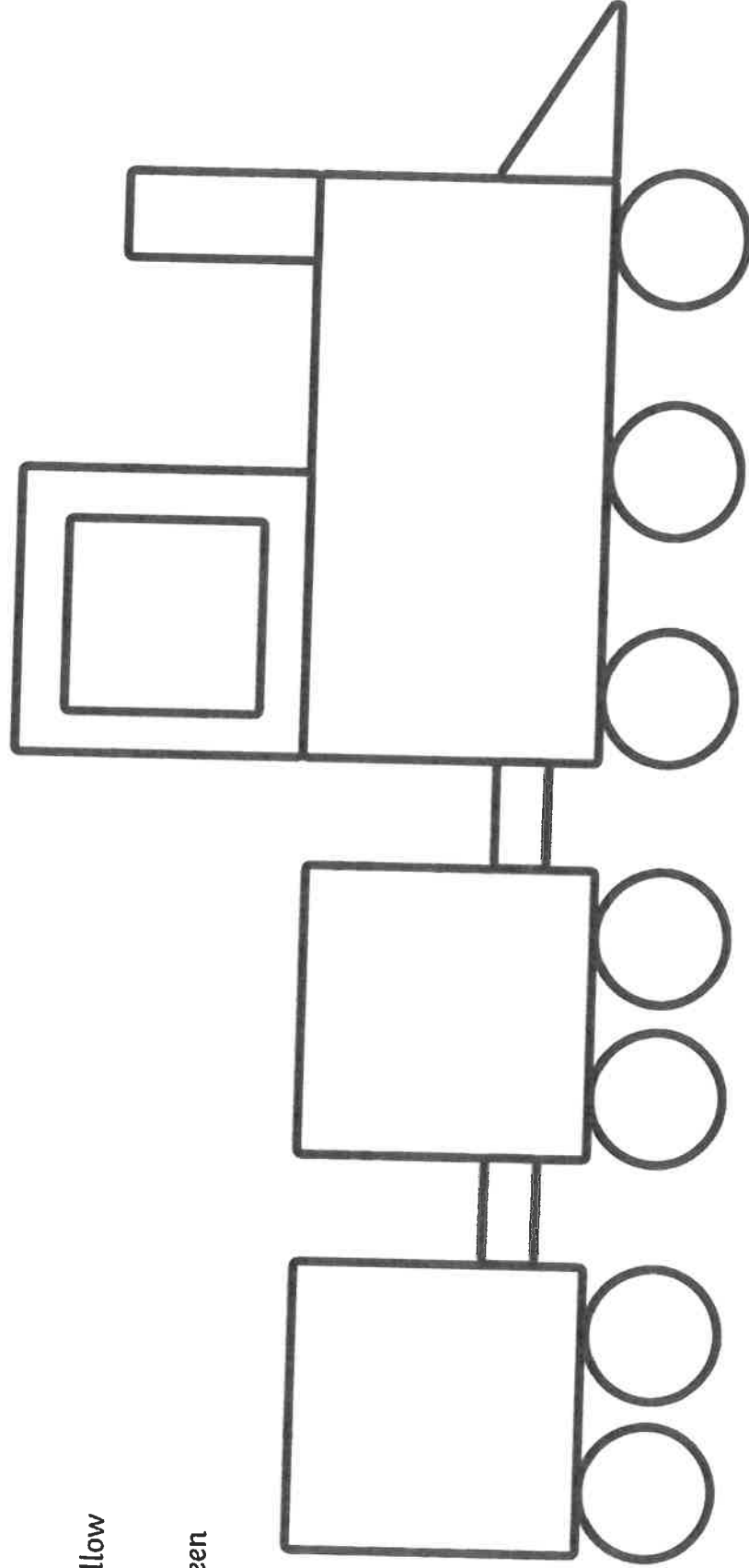

2D Shape Colouring

Can you colour the shapes to complete the picture?

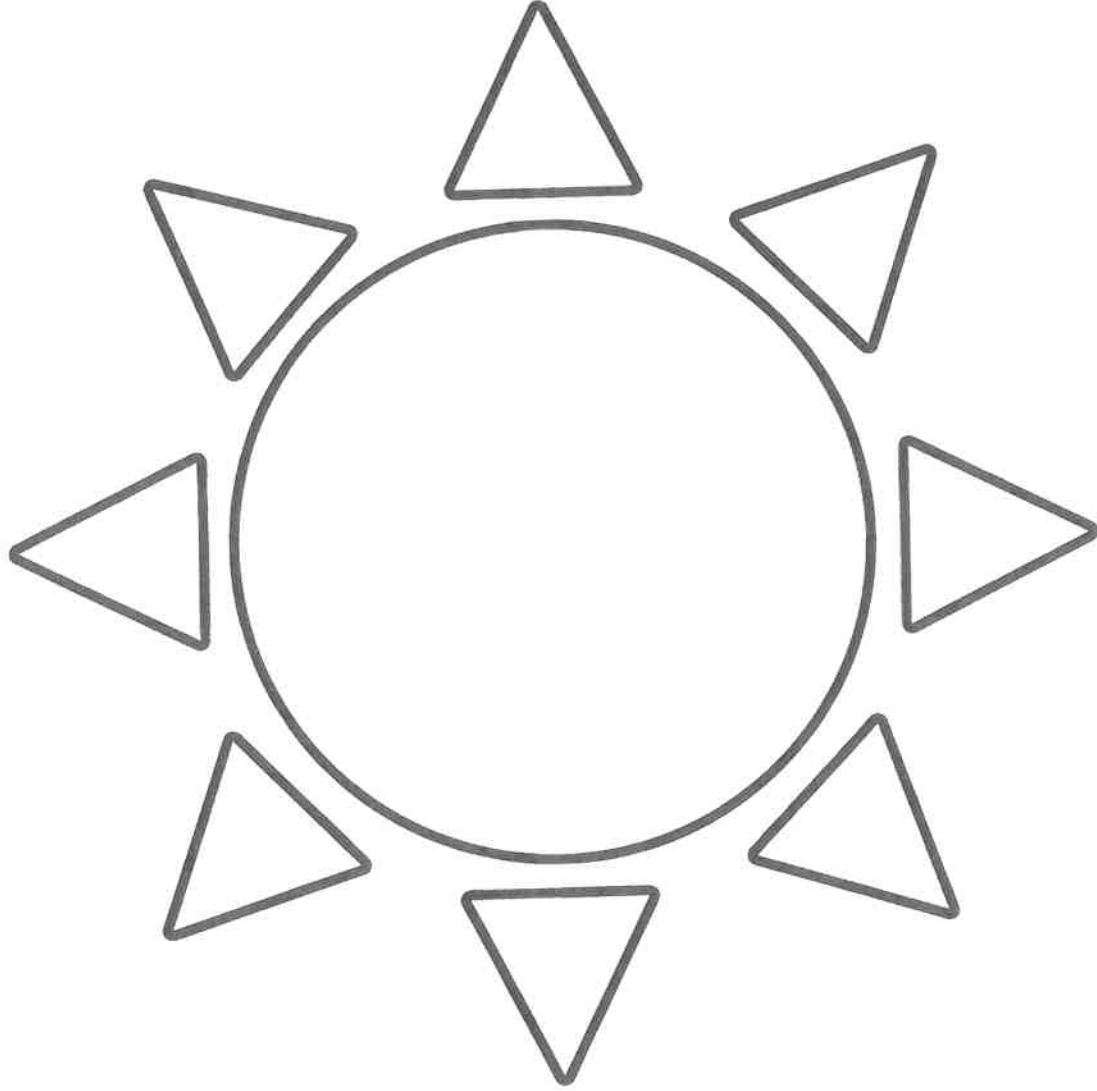

Key:



= yellow



= orange

2D Shape Colouring

Can you colour the shapes to complete the picture?

Key:



= blue



= yellow



= green

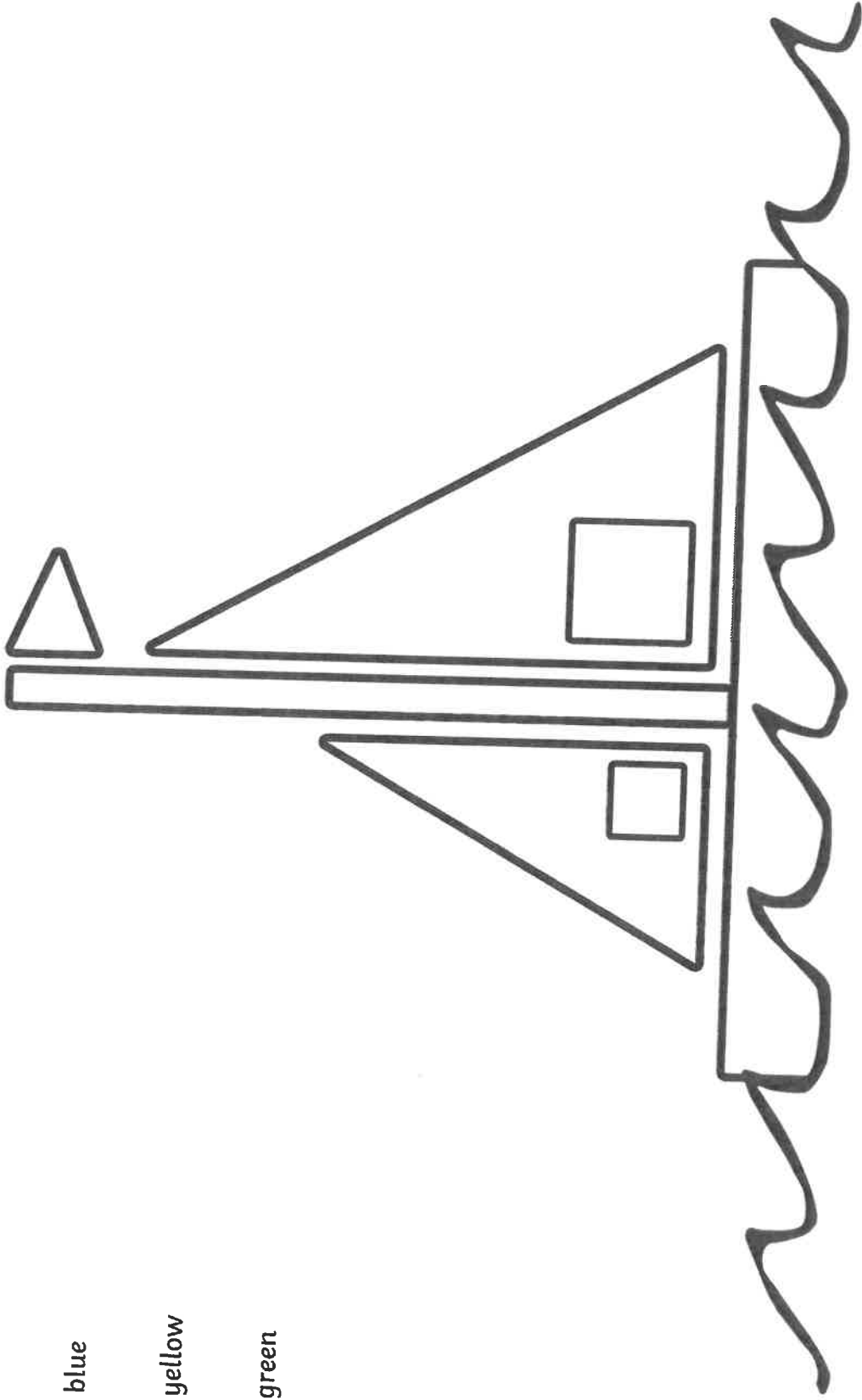

2D Shape Colouring

Can you colour the shapes to complete the picture?

Key:



= purple



= yellow



= green



= blue

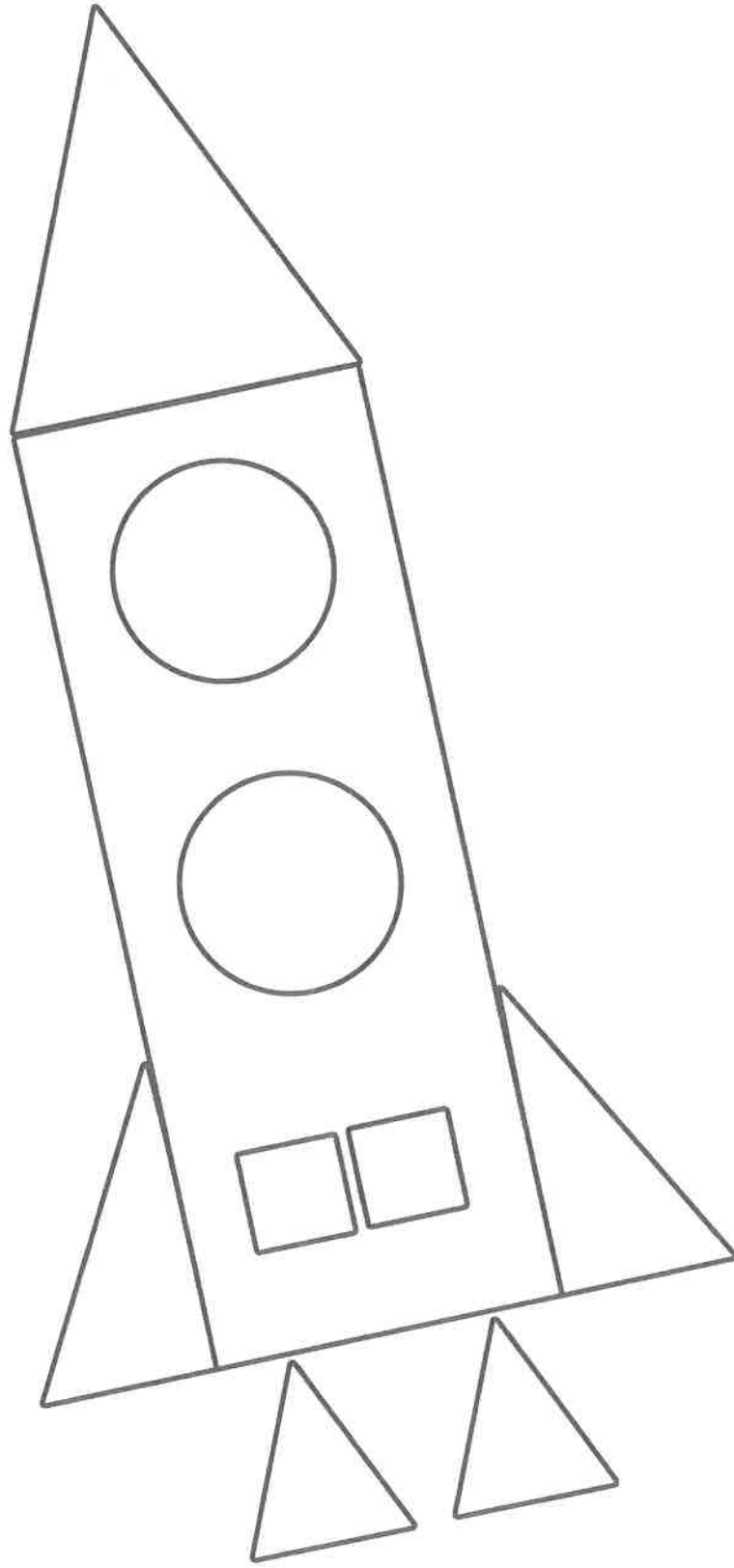



2D Shape Colouring

Can you colour the shapes to complete the picture?

Key:

 = red

 = blue

 = yellow

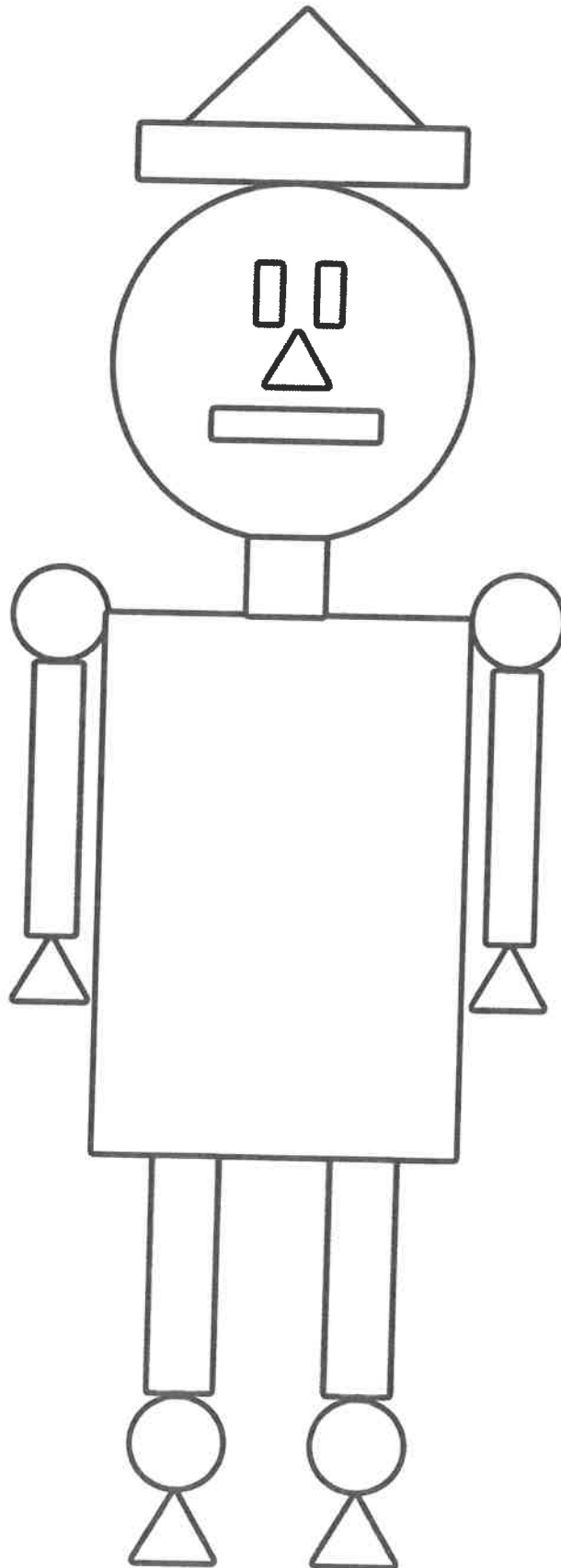



2D Shape Colouring

Can you colour the shapes to complete the picture?

Key:

 = green

 = purple

 = orange

 = yellow

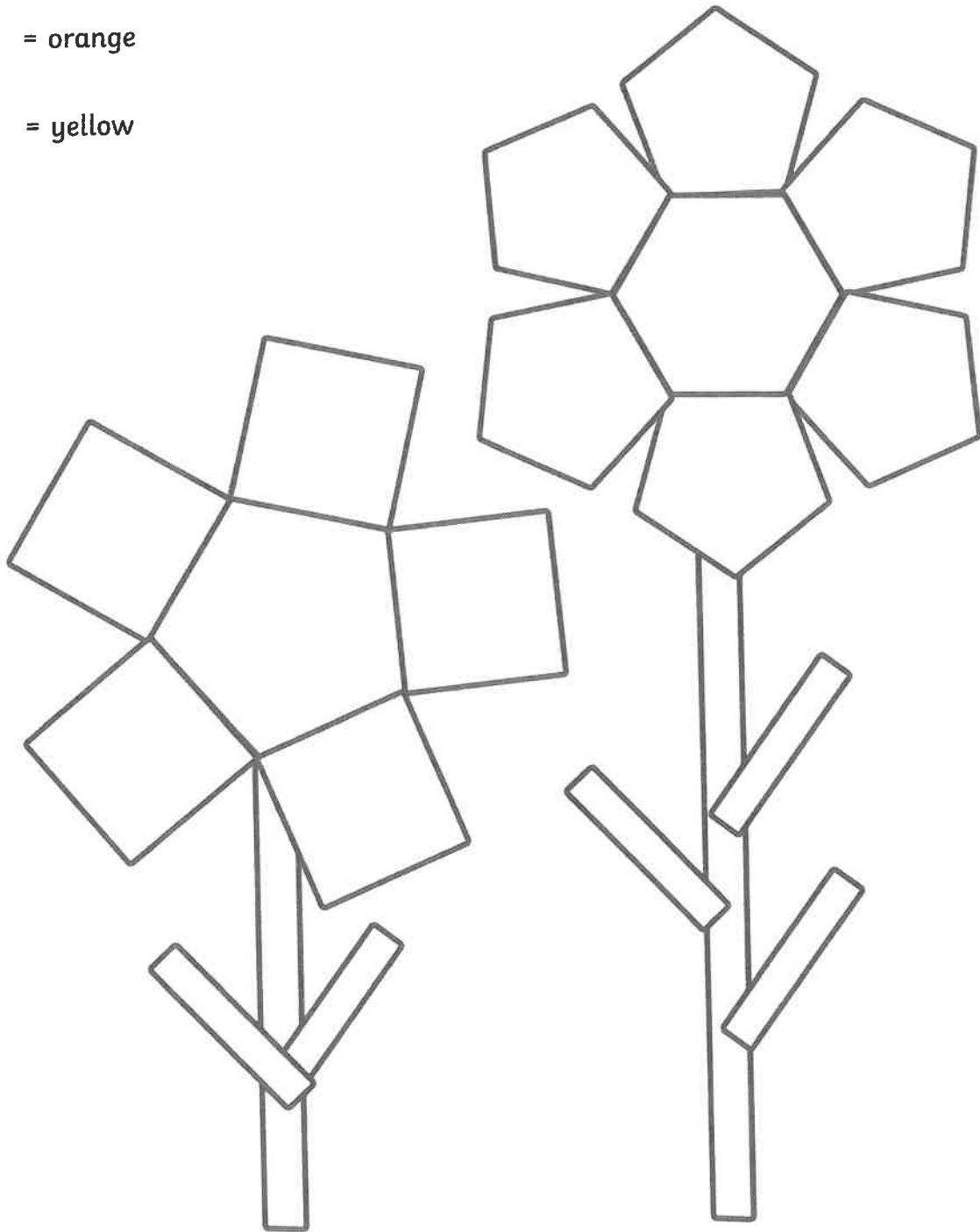



2D Shape Colouring

Can you colour the shapes to complete the picture?

Key:

 = green

 = red

 = blue

 = yellow

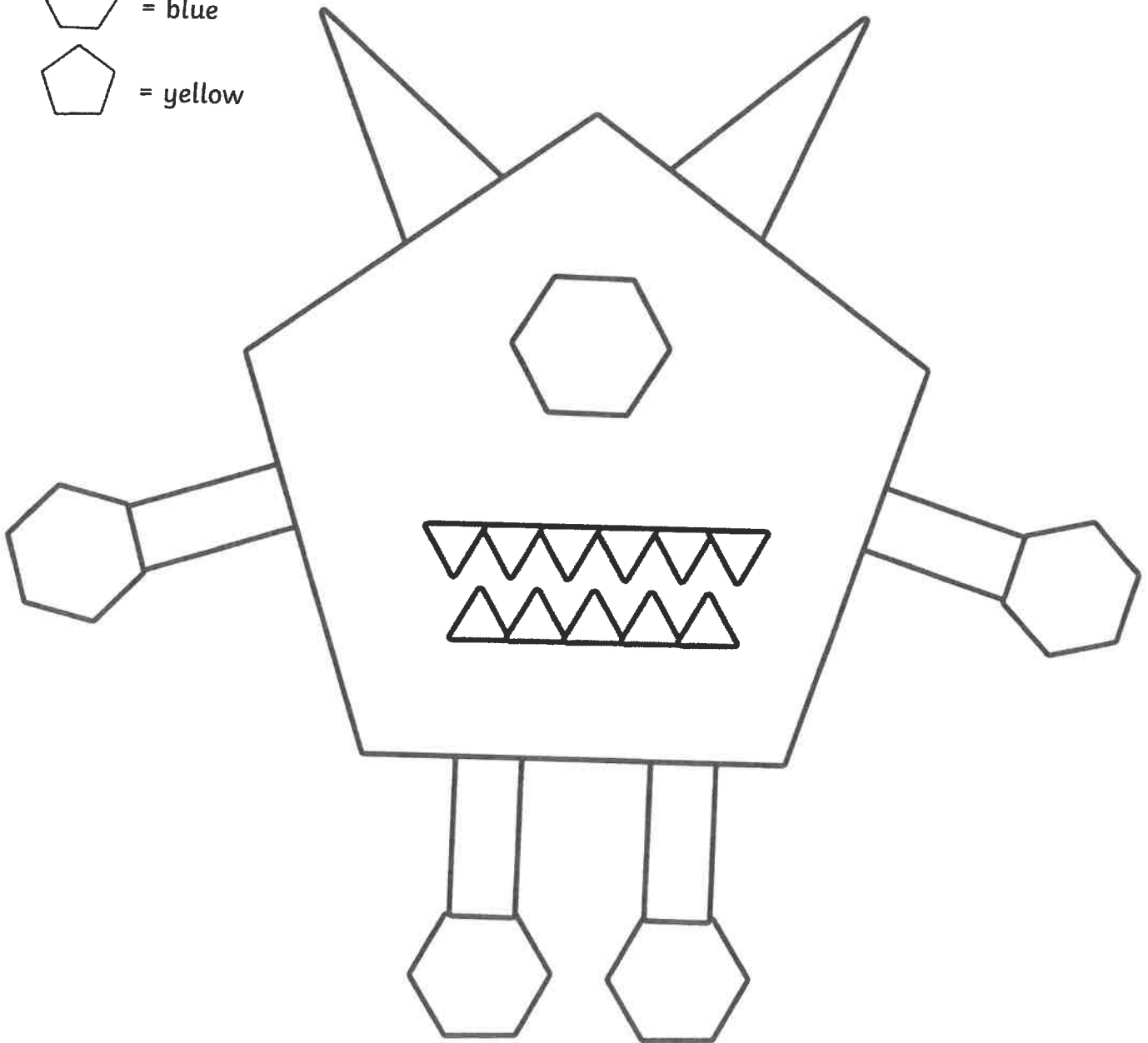



2D Shape Colouring

Can you colour the shapes to complete the picture?

Key:

 = yellow

 = red

 = blue

 = purple

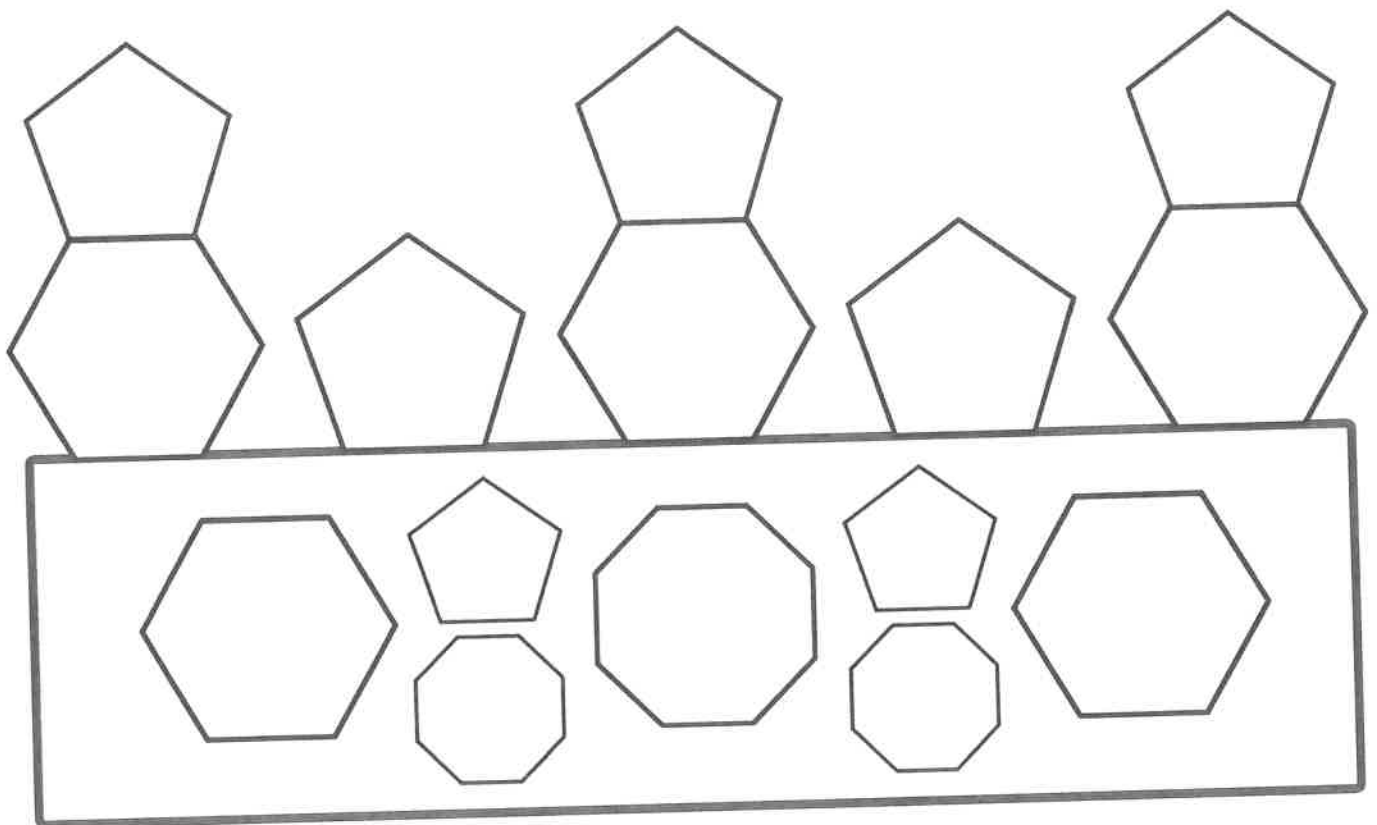

2D Shape Colouring

Can you colour the shapes to complete the picture?

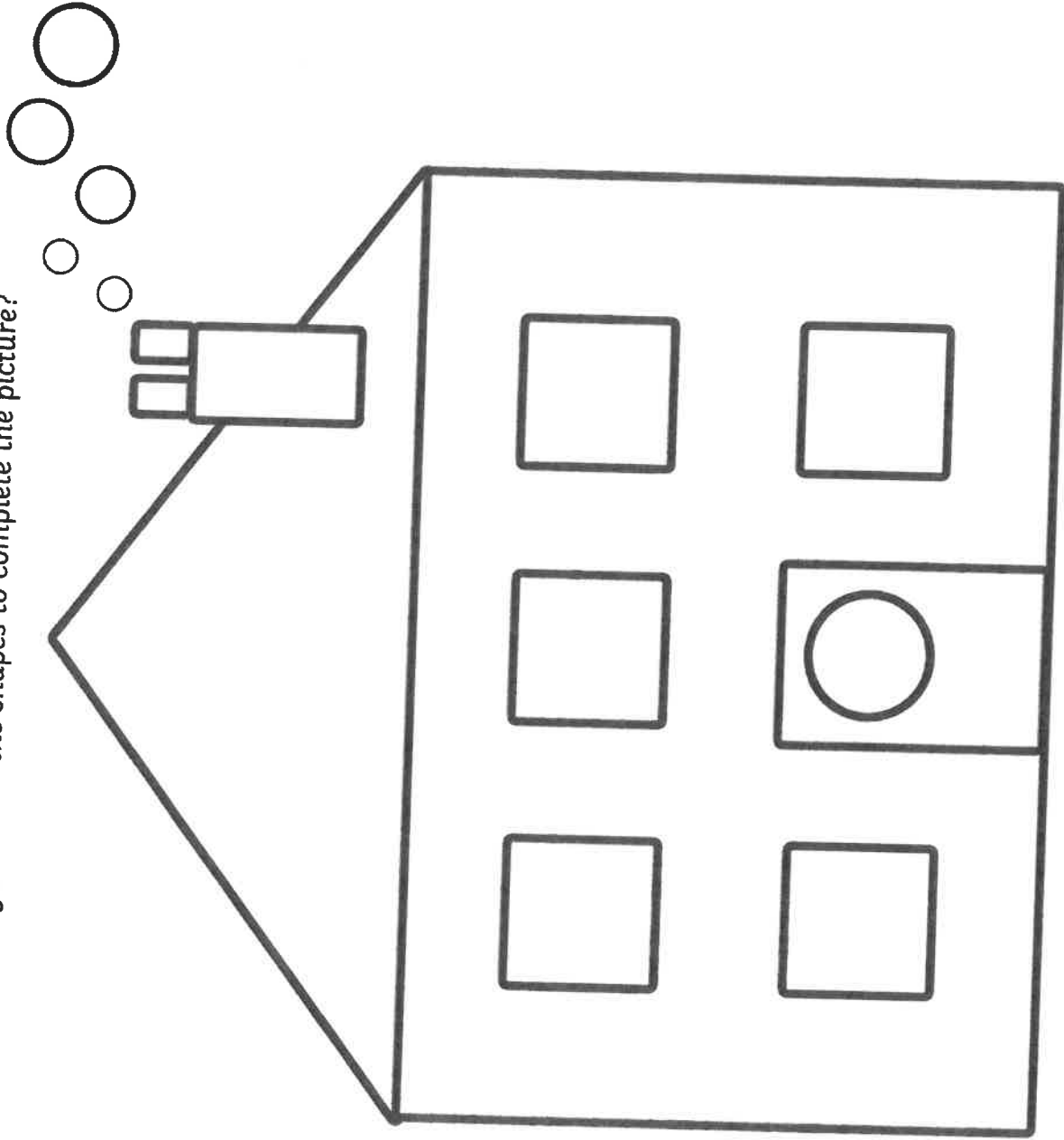

Key:

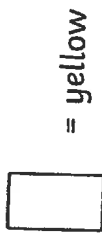

2D Shape Colouring

Can you colour the shapes to complete the picture?

Key:



= red



= blue



= yellow



= green



= purple

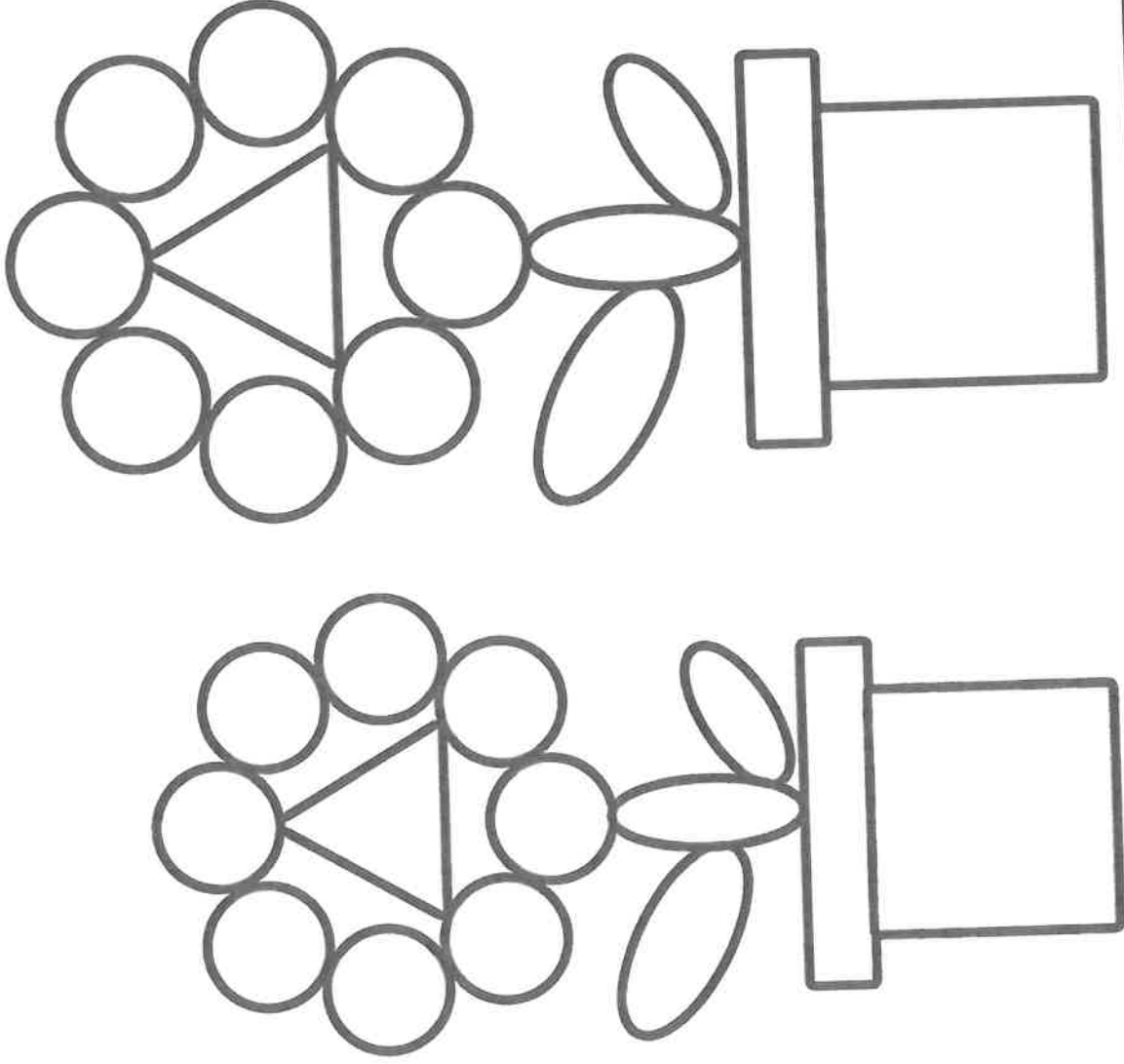

2D Shape Colouring

Can you colour the shapes to complete the picture?

Key:



= brown



= blue



= yellow



= green

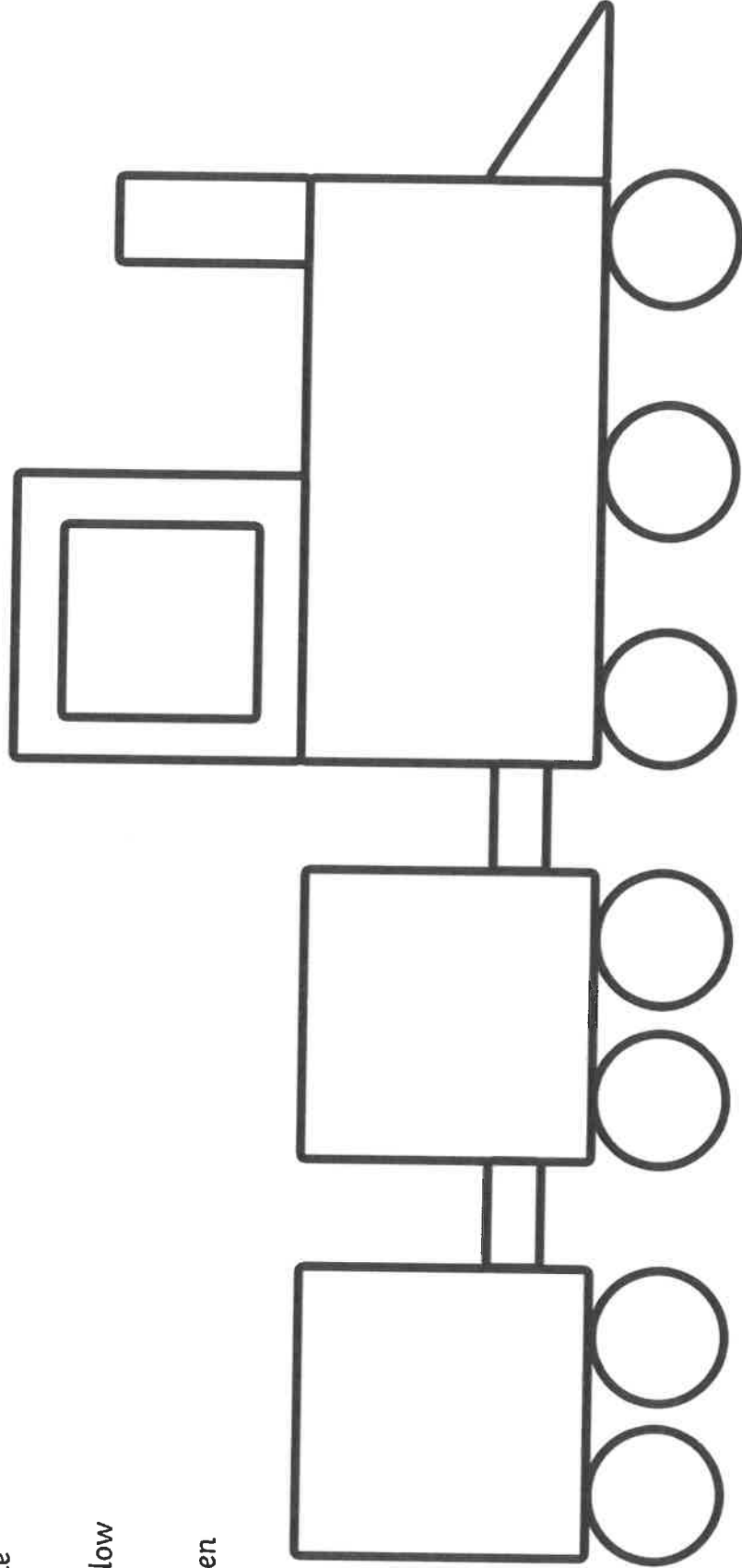

2D Shape Colouring

Can you colour the shapes to complete the picture?

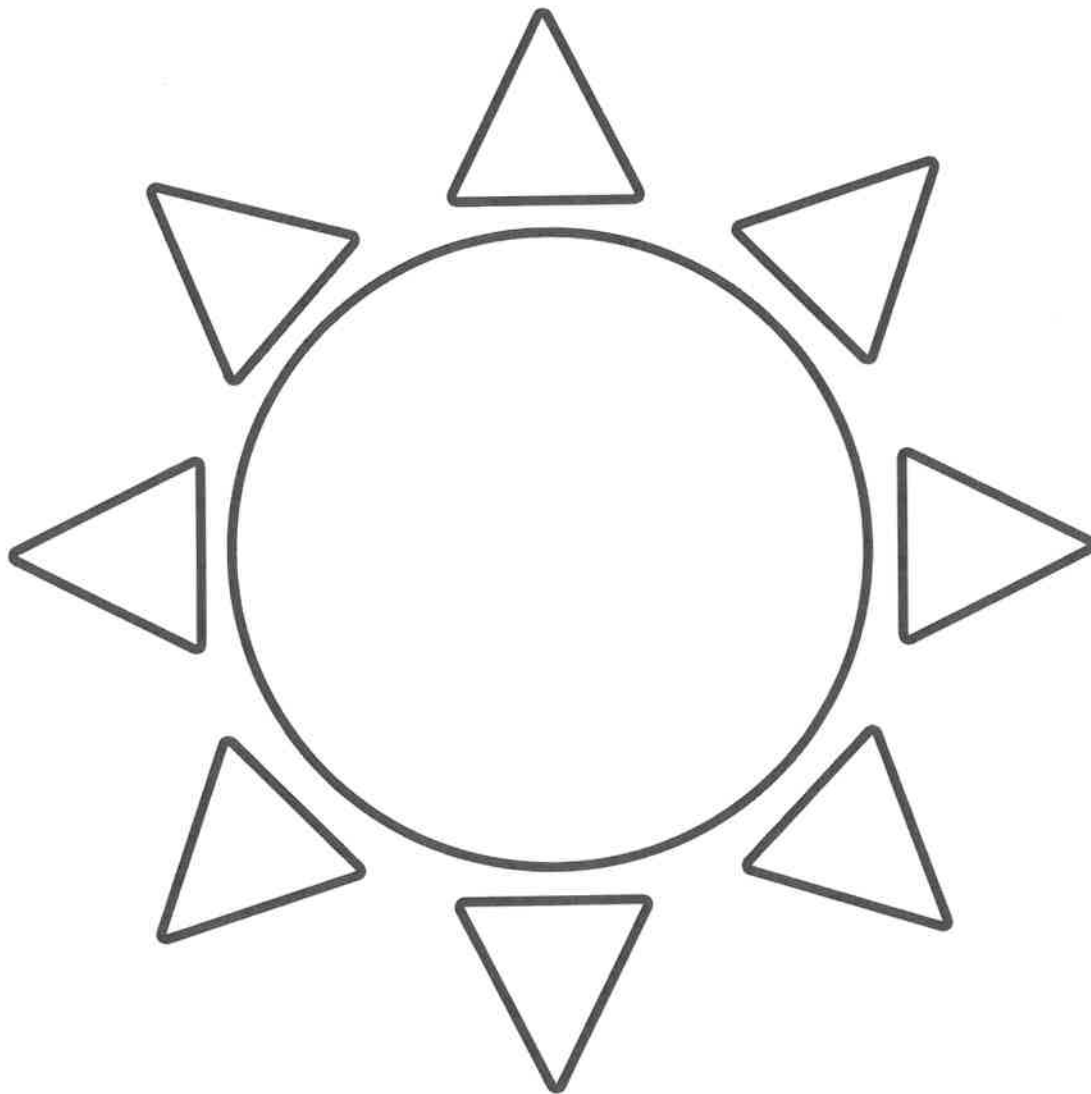

Key:



= yellow



= orange

2D Shape Colouring

Can you colour the shapes to complete the picture?

Key:

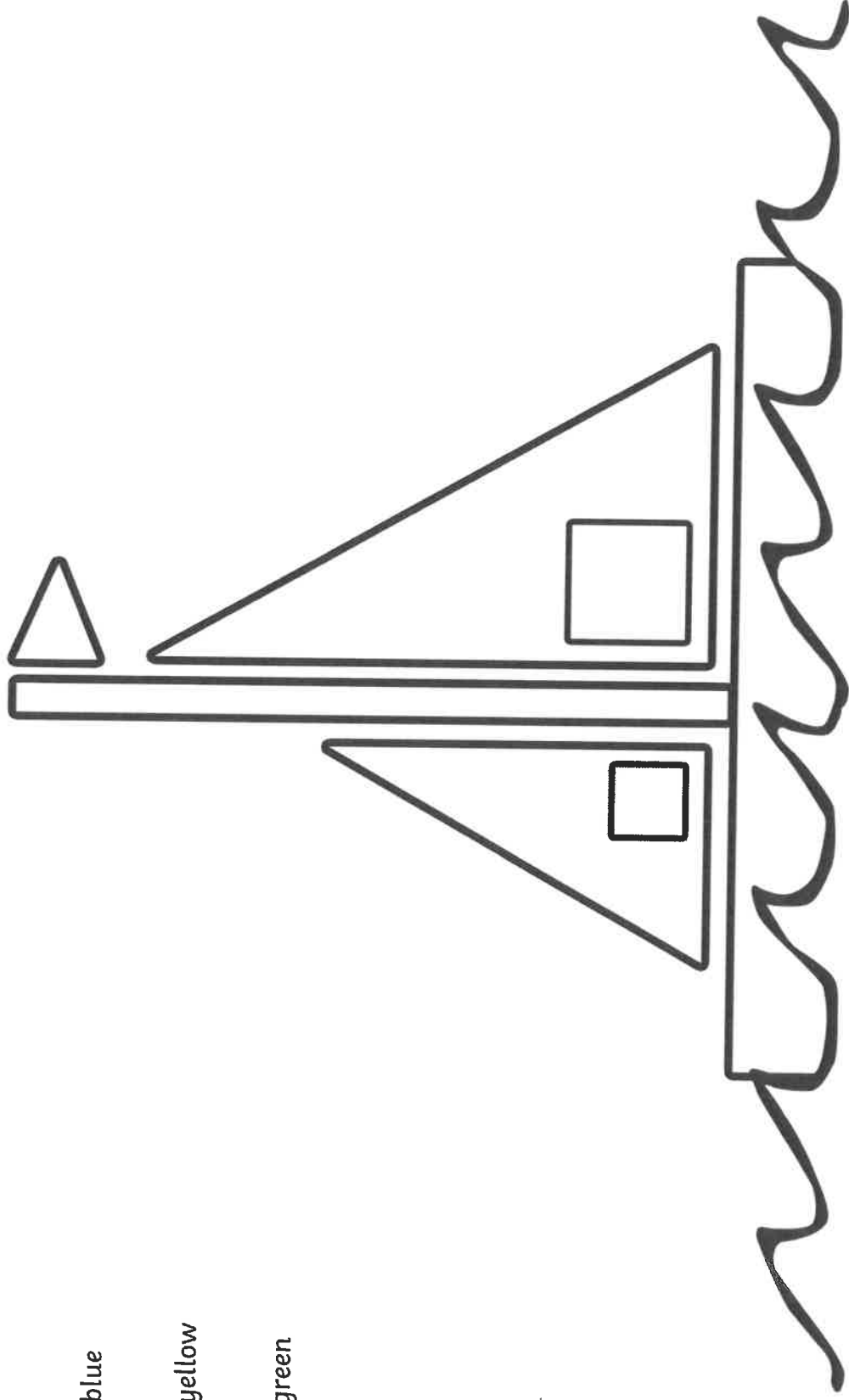
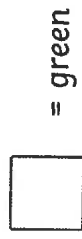

2D Shape Colouring

Can you colour the shapes to complete the picture?

Key:



= purple



= yellow



= green



= blue

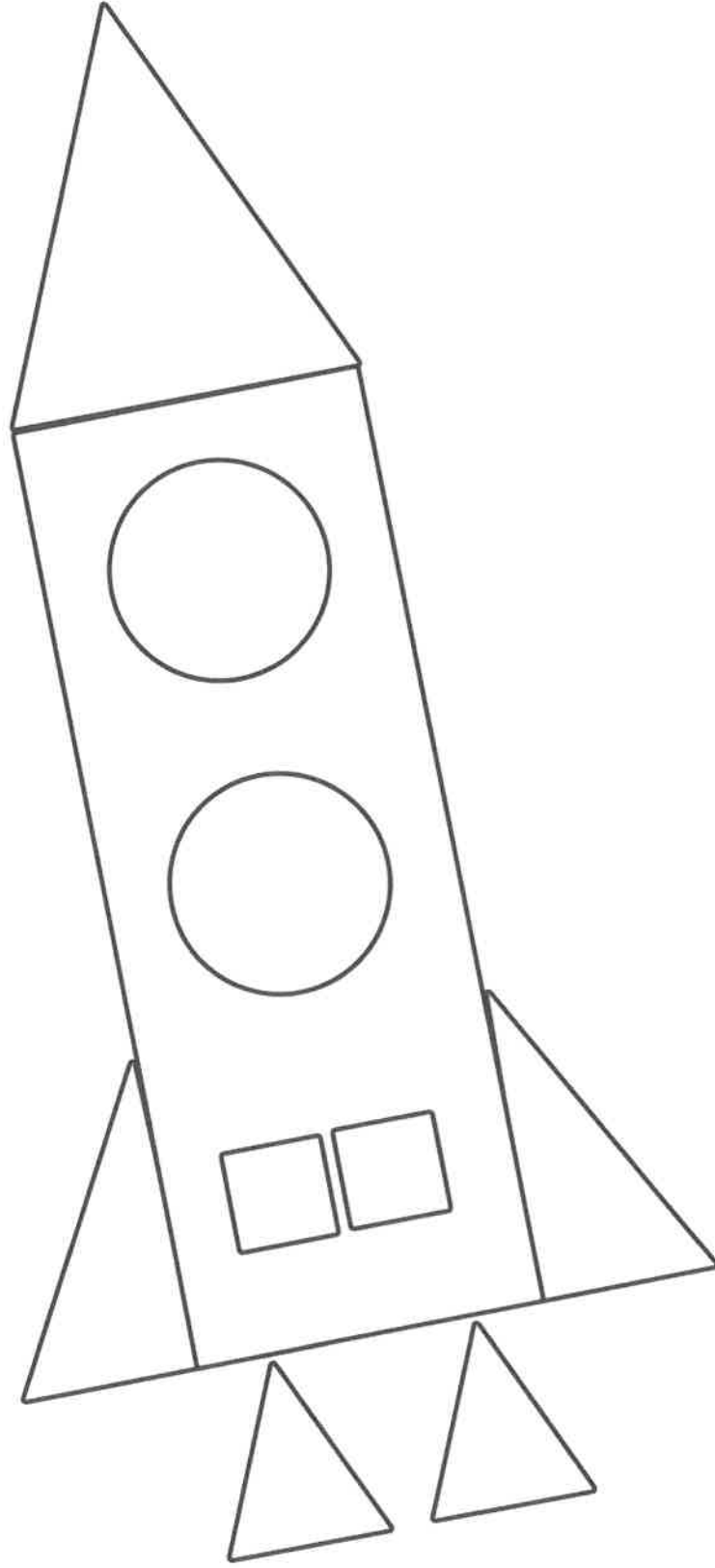



2D Shape Colouring

Can you colour the shapes to complete the picture?

Key:

 = red

 = blue

 = yellow

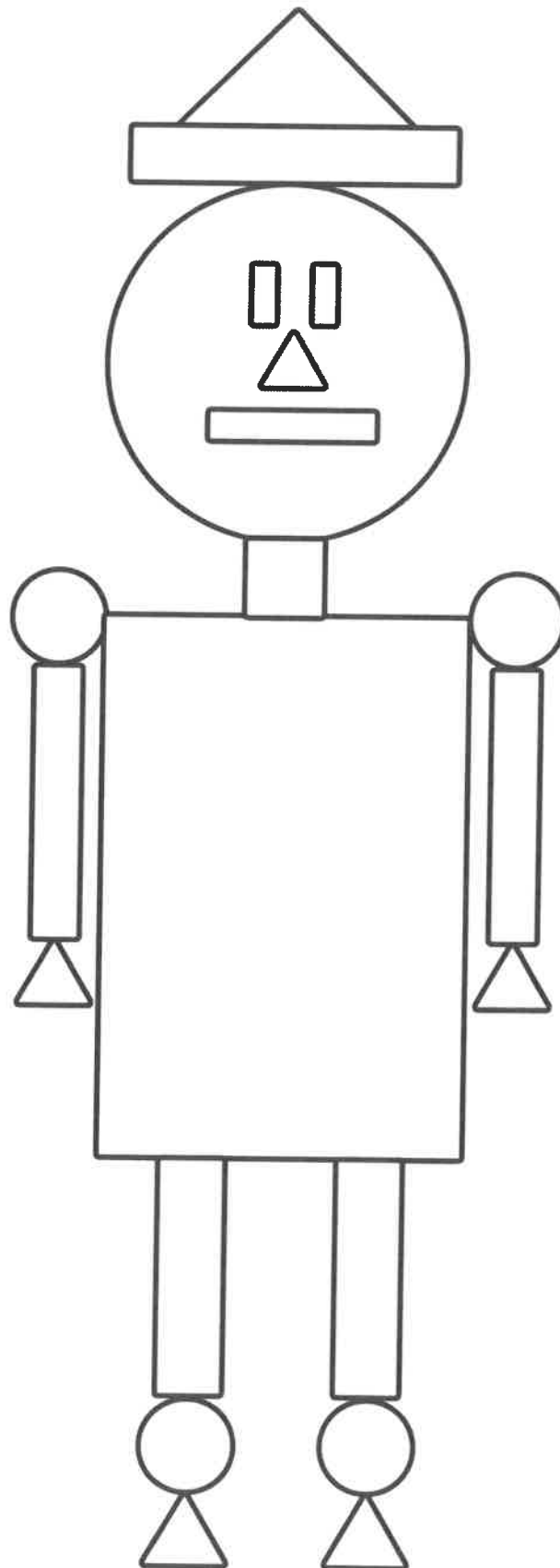



2D Shape Colouring

Can you colour the shapes to complete the picture?

Key:

 = green

 = purple

 = orange

 = yellow

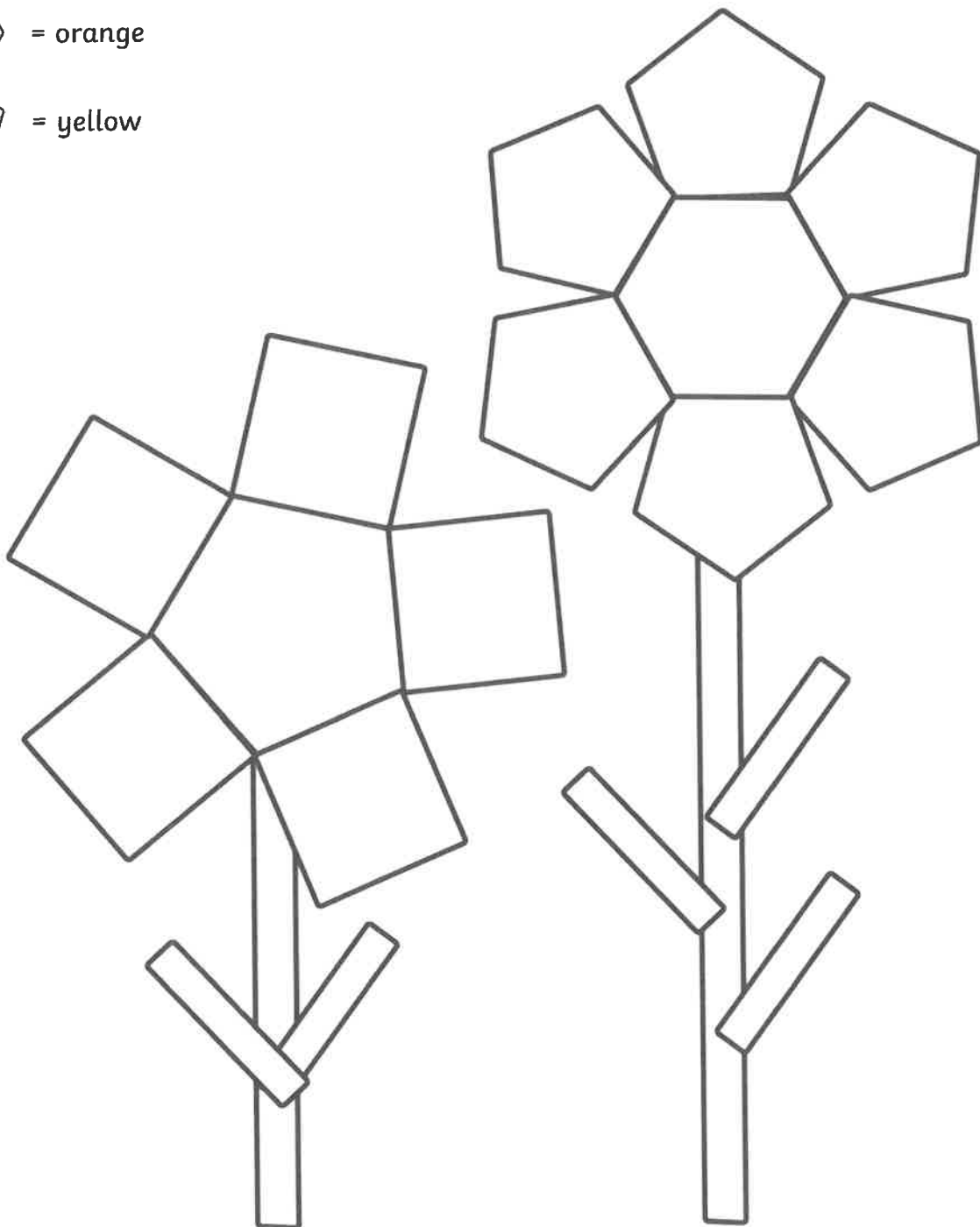



2D Shape Colouring

Can you colour the shapes to complete the picture?

Key:

 = green

 = red

 = blue

 = yellow

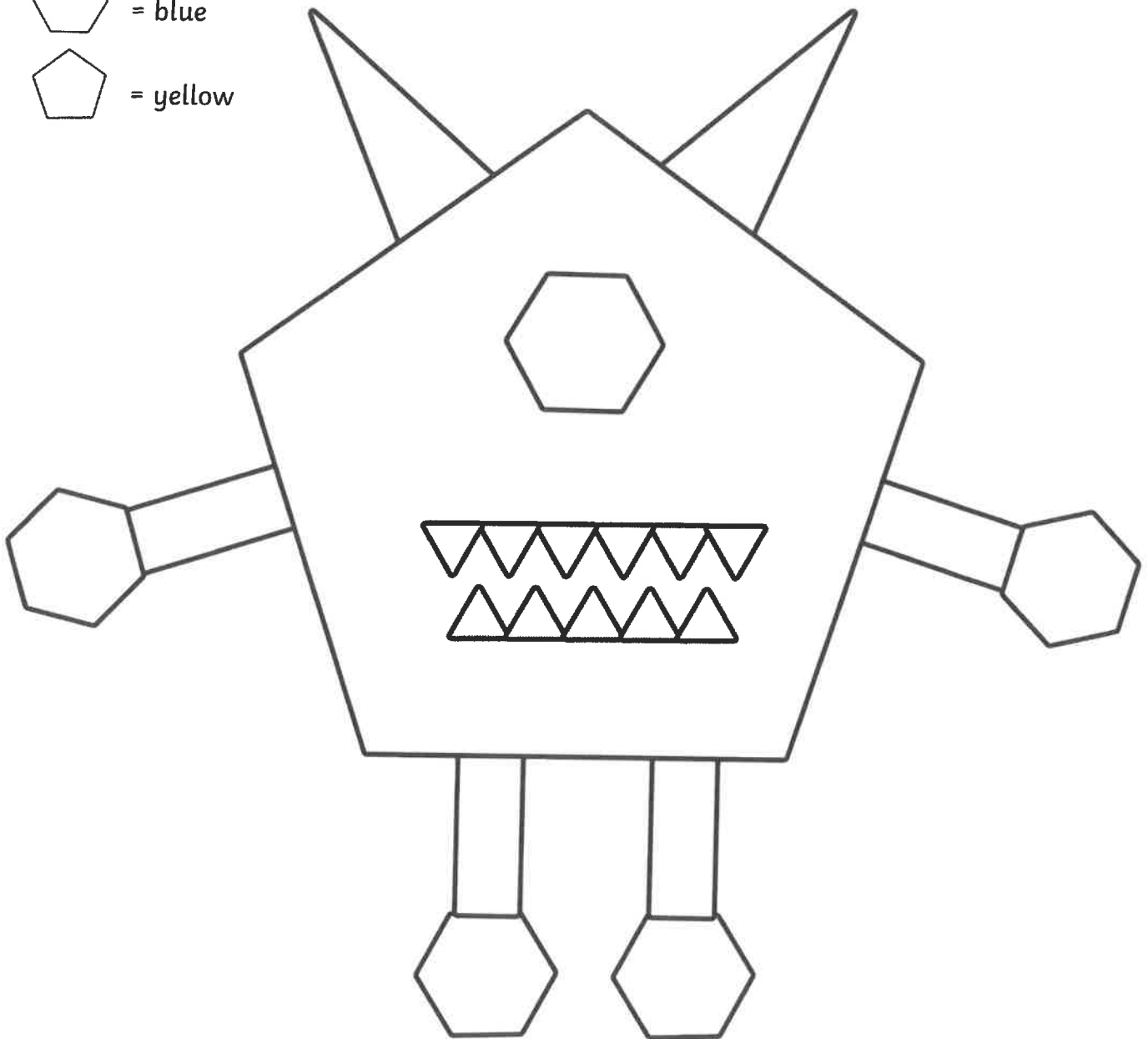



2D Shape Colouring

Can you colour the shapes to complete the picture?

Key:

 = yellow

 = red

 = blue

 = purple

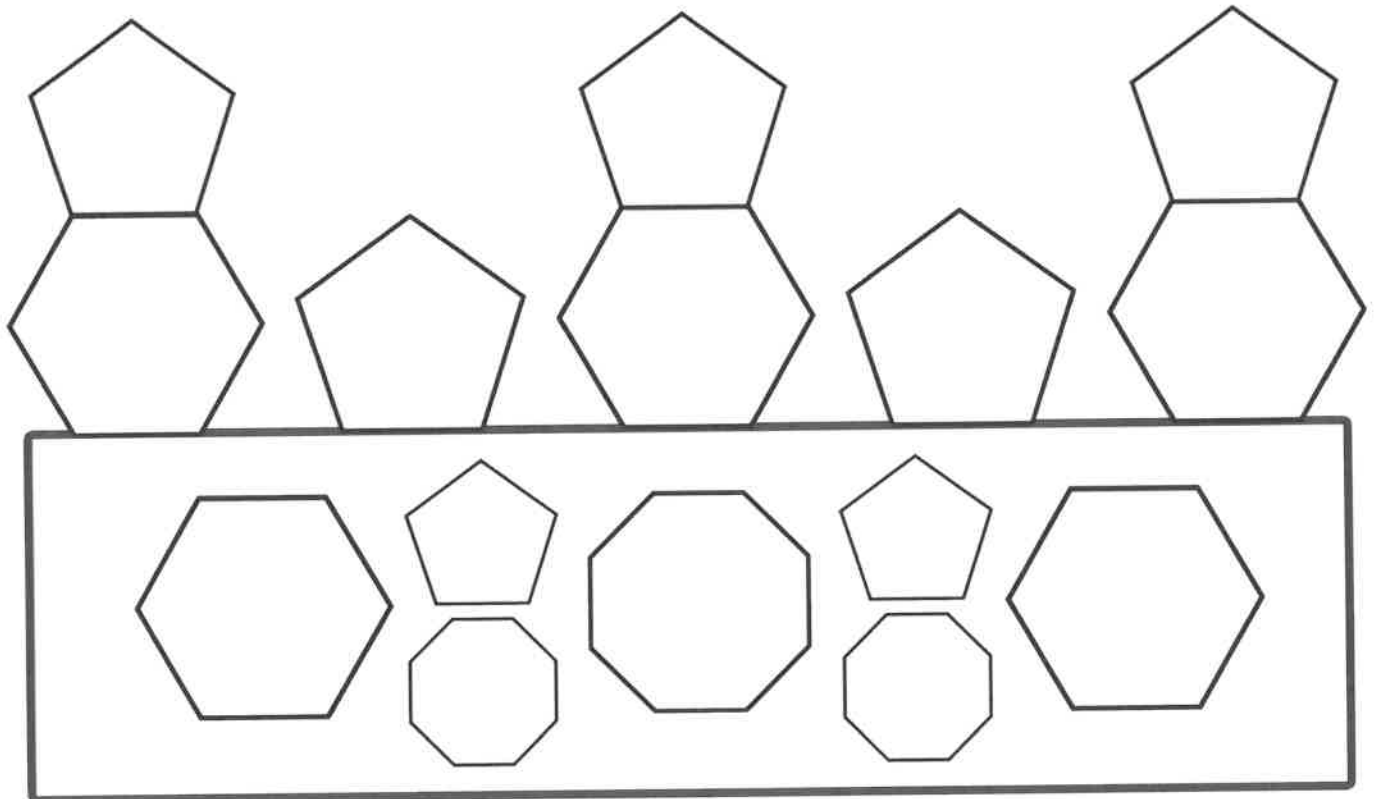

Star Number Bonds to 10

Write the missing number to make each star equal to 10.

6 +

8 +

10 +

2 +

5 +

9 +

1 +

3 +

7 +

4 +

0 +

10

Star Number Bonds to 10 Answers

Write the missing number to make each star equal to 10.

6 + 4

8 + 2

10 + 0

2 + 8

5 + 5

9 + 1

1 + 9

3 + 7

7 + 3

4 + 6

0 + 10

10

Maths: Counting and Ordering Numbers to 20

Home Learning Challenges

Write out the numbers 0-20 on some paper or card, cut them up and then ask a grown-up to mix the numbers up – don't peek! Then, see how quickly you can put them into the correct order. You could ask someone to time you and then see if you can get faster when you try again.

Draw circles on a piece of paper and put different coloured paints in shallow trays. Choose a number between 1 and 20. Dip your finger into paint and add that many petals to one of the circles, making a flower. Count the petals to check how many you have and write that number in the middle of the circle. Choose another number and do the same to another circle on your page. Fill up your page with colourful flowers, each with different amounts of petals.

Collect 20 leaves from your garden or a local park. Write the numbers 1-20, one on each leaf, using a thick marker pen. Use a hole punch to make a hole in either end of the leaves and then thread them onto a piece of string. Don't forget to put them in the correct order! You could then put up your homemade number line in your bedroom to help you remember the order of the numbers.

Next time you open a packet of raisins, some carrot sticks or apple pieces, count out how many you have. If you're eating them with a friend, count how many they have too. Can you write the numbers down?

Write the numbers 0-20 on plastic building bricks. Make a tower of 21 bricks, seeing if you can put the numbers in the correct order. Start with 0 at the bottom and 20 at the top and then try starting with 0 at the top and 20 at the bottom.

Ask an adult to hide the numbers to 20 around your room, house or garden. See if you can find all 20 and place them in order. You could ask someone to tell you a number to find. Can you remember what the number looks like and find it?

Ordering to 20 Cut and Stick Activity Sheet

1		3	4			7			10
11			14		16		18	19	

Cut out the numbers below. Stick them in the correct order above.

8	20	15	12	9	2	17	13	6	5
---	----	----	----	---	---	----	----	---	---

MINDFULNESS

LEARNING

- FROM -

HOME

 teachstarter

MINDFULNESS

CONTENTS

Mindfulness Activity Task Cards

These task cards contain 17 mindfulness exercises and instructions for each. You may choose to select a different activity for students to complete each morning.

Gratitude Journal Writing Prompt Cards

Use these writing prompt cards as part of daily gratitude practise to help increase positivity and mindfulness, and to encourage a growth mindset. Select a writing prompt card and ask students to complete the activity in a journal or workbook.

Body Scan: Guided Meditation Script

Read this script aloud to guide students through a Body Scan meditation. A Body Scan meditation is sometimes referred to as 'progressive relaxation', as it helps calm the body and mind.

Breathing Colours: Guided Meditation Script

Read this script aloud to guide students through a mindful visualisation and breathing meditation. It encourages students to imagine the breath as a colour, which improves focus and awareness and helps develop conscious relaxation skills.

Mindful Breathing: Guided Meditation Script

Read this script aloud to guide students through a mindful breathing meditation. This meditation teaches students practical mindfulness skills that can serve them throughout many aspects of their lives.

Mindfulness Colouring-in Pinwheel Activity

This template encourages students to use a paper straw, thumb tack, and a stopper to create a paper pinwheel that can be used for mindful breathing activities. While it's true that pinwheels do turn better on a real pin, the activity includes instructions for a pin free/split-pin assembly too.

Nature-Inspired Gratitude Writing Prompt Sheets

Use these nature-themed gratitude writing prompt sheets to help students share the joy they find in nature, whether in their backyards or on their balconies. Students can use the sheets to brainstorm ideas, words or phrases. Alternatively, they could use them as a part of a reflective prose writing activity

Yoga Poses for Kids

Choose one or more of the yoga cards for students to focus on. These yoga activities improve students' gross motor skills, concentration and general fitness levels.

Mindfulness Colouring Sheets

Colouring is a valuable relaxation and mindfulness activity. These beautifully illustrated colouring sheets offer a calming 'brain-break' for students.

MINDFULNESS

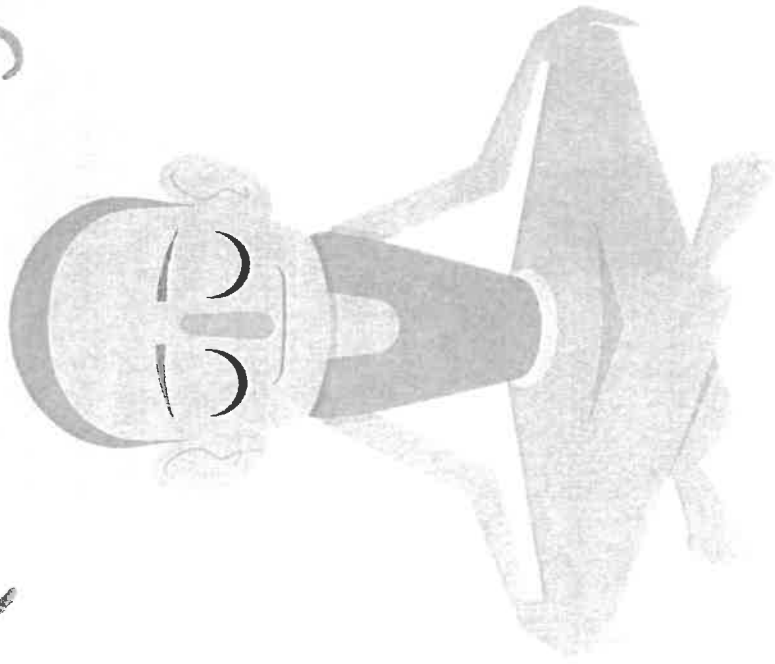

Activity Task Cards

MINDFUL BREATHING

1. Sitting or standing, place your hands on your belly. Close your eyes, or look down towards your hands.
2. Take three slow, deep breaths in and out.
3. In your mind, count '1, 2, 3' for each breath in and '1, 2, 3' for each breath out. Pause slightly at the end of each exhale.
4. Continue for 3 to 5 minutes or until the teacher says, "Stop"

Guiding Questions

- Can you feel your hands moving?
- What is moving your hands? Is it the air filling your lungs?
- Can you feel the air moving in through your nose?
- Can you feel the air moving out through your nose?
- Does the air feel a little colder on the way in and warmer on the way out?
- Can you hear your breath?
- What does it sound like?

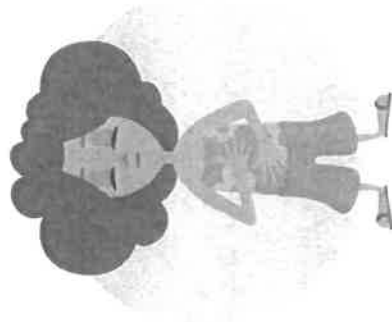

PINWHEEL BREATHING

Materials: a pinwheel

1. Sitting or standing, hold your pinwheel in front of you. Focus your attention on it.
2. Take a deep breath in through your nose
3. Breathe out gently through your mouth and see if you can make your pinwheel spin.
4. In your mind, count '1, 2, 3' for each breath in and '1, 2, 3' for each breath out. Pause slightly at the end of each exhale.
5. Continue for 2 to 3 minutes or until the teacher says, "Stop".

Guiding Questions

- Is the pinwheel moving quickly or slowly?
- Can you feel the air moving in through your nose?
- Can you feel the air moving out through your mouth?
- Can you hear your breath?
- How does the handle of the pinwheel feel against the skin of your palm?



BELLY BUDDIES

Materials: small lightweight object such as a soft toy, a small beanbag or a wooden block

1. Lie flat on your back and place the object on top of your belly button. Look down towards your object.
2. Take three slow, deep breaths in and out.
3. In your mind, count '1, 2, 3' for each breath in and '1, 2, 3' for each breath out. Pause slightly at the end of each exhale.
4. Continue for 3 to 5 minutes or until the teacher says, "Stop"

Guiding Questions

- Can you feel the weight of your object on your belly?
- Can you see your object moving?
- What is moving your object? Is it the air filling your lungs?
- Can you feel the air moving in through your nose?
- Can you feel the air moving out through your nose?
- Can you hear your breath?



SHARK FIN

1. Sit or stand comfortably. Keep your body straight. Be still and silent. Soften your breath and shut your eyes.
2. Place the side of your hand on your forehead, with your palm facing out to the side.
3. Slide your hand down your face, in front of your nose.
4. Say "Shhh" as you slide your hand down your face.
5. Complete this once, or repeat 2 to 3 times.



BREATHING COLOURS

1. Sit or stand comfortably. Keep your body straight. Be still and silent. Soften your breath and shut your eyes.
2. Think of a relaxing colour. It can be any colour, as long as it reminds you of relaxing.
3. Now think of a colour that represents stress, sadness or anger.



4. Imagine you are surrounded by the relaxing colour. No longer is the air clear; it is the relaxing colour.
5. Take a deep breath in and imagine breathing in the relaxing colour. Imagine the colour filling your lungs.
6. As you breathe out, imagine that your breath is the colour of stress.
7. See the stress colour mix into the relaxing colour around you. Watch it disappear.
8. Breathe in your relaxing colour. Breathe out your stress colour.
9. Continue for 3 to 5 minutes or until the teacher says, "Stop"

BREATH STAR

1. Spread one hand out like a star.
2. Use the index finger on your other hand to trace the outline of your star hand.
3. Take a deep breath in as you move your tracing finger to the top of your thumb.
4. Breathe out as you move your tracing finger down between your thumb and first finger.
5. Take another breath in as you move to the top of your first finger.
6. Breathe out as you move down between your first and second fingers.
7. Continue this pattern, tracing each of your fingers until you have taken five slow, deep breaths.
8. Repeat on the other hand.

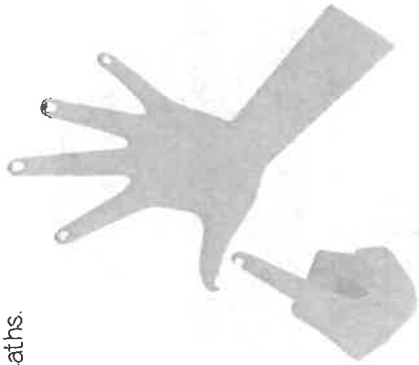

BACK-TO-BACK BREATHING

1. Find a partner. Sit with your back resting against your partner's back.
2. Sit up straight. Be still and silent. Soften your breath and shut your eyes.
3. Take three slow, deep breaths in and out.
4. In your mind, count '1, 2, 3' during each breath in and '1, 2, 3' during each breath out. Pause slightly at the end of each exhale.
5. Continue for 3 to 5 minutes.



Guiding Questions

- Can you feel your partner's back moving as they breathe?
- Is their breath shallow or deep? Fast or slow?
- Did your breath fall into sync with your partner's? In what way?

BODY SCAN

1. Stand or lie comfortably. Keep your body straight. Be still and silent. Soften your breath. Shut your eyes or look towards your hands or the ceiling.
2. Take three slow, deep breaths in and out.
3. Focus on your feet for 5 to 10 seconds
 - How does this body part feel?
 - Is it cold or warm?
 - Does it feel tight or relaxed?
 - Is all, or part, of that body part touching the floor?
 - Can you feel any clothing against your skin?
 - What does it feel like?

4. Move your focus to your toes, then your ankles, then your calves and then your knees. Consider the above questions at each 'stop'.

5. Continue, body part by body part, until you reach your head.

6. If you feel any tightness or stress in a particular area, imagine breathing the stress out of that body part with each exhale.



MINDFUL EATS

Materials: a small piece of allergy-friendly food such as chocolate or fruit



1. Sit straight and still. Close your eyes or look downwards.
2. Take three slow, deep breaths in and out.
3. Hold the food up to your nose and take a deep breath in. Notice the smell and how the smell makes you feel.
4. Take a small bite of the food. Let it sit in your mouth awhile before you swallow it.
5. Notice which muscles in your mouth, neck and body move as you eat.
6. Pause between each bite and notice any changing sensations in your mouth or body.
7. Continue eating your food slowly and mindfully.

Guiding Questions

- What is the taste like? Is it sweet or savoury?
- What does the food feel like on your tongue?
- Do you need to crunch it between your teeth, or can you slowly dissolve it in your mouth?
- Try taking a slightly smaller or slightly larger bite. How does this change the way eating this food feels?

MINDFUL STEPS

1. Head outside and find a small area where you can walk in a line for five steps, then turn and walk back again, without interruption. You may like to take off your shoes and socks.
2. Stand still and straight. Take three slow, deep breaths in and out.
3. Take five steps in one direction, walking slowly and noticing how your body moves with each step.
4. Listen to the sounds around you and the sound your feet make on the ground. Try not to change the way you walk, but instead just notice how your body naturally moves.

Guiding Questions

- What does the ground feel like under your feet?
- When you take a step, which part of your foot touches the ground first?
- Does your body feel heavy or light today?
- Are you slouching when you walk or is your back up straight?

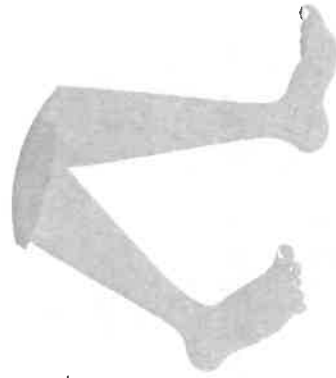

MINDFUL SOUNDS

Materials: live or recorded sounds such as a ringing bell, nature sounds or calming music



1. Sit straight and still. Close your eyes and take three deep breaths in and out.
2. When you begin to hear a sound, concentrate on what you can hear.
3. Pay attention to whether you hear it louder in one ear than you do in the other.
4. Keep your eyes closed until the sound is completely gone.
5. If you notice your thoughts wandering, bring your attention back to the sounds you can hear.
6. After you open your eyes, remain silent until you hear a voice again.

Teacher Notes

- Students close their eyes while the teacher initiates the sounds.
- The activity is finished when the sound has completely dissipated.

SUPER SENSES

- 1 Sit or stand straight and still. Close your eyes or look downward.
- 2 Take three deep breaths in and out. Then, open your eyes.
- 3 Turn up' your senses to a superhuman level. You will begin to see, hear, smell, taste and feel more than an ordinary human being.
- 4 Focus on what you can hear. Listen intently to the sounds around you, beyond the space you are sitting in now and out in the wider world.
- 5 Think about what you can see. Pay attention to tiny details that you may not usually see, like the slightly curled edge of a piece of paper, or a speck of dust on a table.
- 6 What can you taste? Is your mouth dry? Is your tongue relaxed?
- 7 What can you smell? Is there a strong or subtle smell in the air?



- 8 Notice what you can feel, such as the weight of your body on the chair, or your feet in your shoes, or the temperature of the air
- 9 Keep your super senses switched on until the teacher says, "Stop"

A MOMENT OF GRATITUDE

- 1 Sit or stand straight and still. Close your eyes or look downward.
- 2 Take three deep breaths in and out
- 3 Think of something you feel grateful for today. This is your 'gratitude moment'
- 4 Think about how this moment affects your life, or the lives of people around you.
- 5 Notice how you feel when you think about your 'gratitude moment'.
- 6 Let the feeling grow bigger, spreading from where it is until it fills your entire body

Suggested Gratitude Prompts

- Something that someone else did for you today
- A person in your life whom you appreciate
- An activity or hobby you are grateful to be able to do
- A positive quality of someone who can sometimes be hard to get along with
- A skill or ability you have
- A part of your body you are grateful for and why
- An item that you love
- Something that made you laugh
- What you have learned from something that was hard.



SENSORY BOTTLE

Materials: a sensory bottle filled with small floating objects or coloured liquid bubbles

1. Shake the bottle well so that its contents are all mixed up.

Imagine that the stirred-up bottle is like your mind when you are feeling stressed, angry or upset. Just like it is hard to see the contents of the bottle clearly, it is hard to think clearly when we are upset.

2. Place the bottle down on a table.

Watch what happens when the bottle is still for a few moments.

Notice how its contents begin to settle and the water clears. Our mind and our feelings work the same way.

When we stop and are still for a little while, hard feelings feel less intense and we can see things more clearly.

Follow the falling objects or coloured bubbles with your eyes until every last one has settled at the bottom of the bottle.

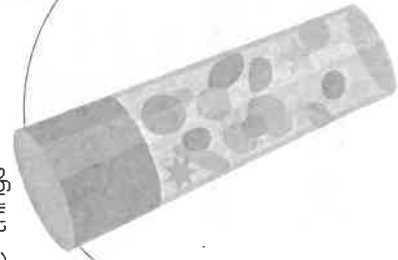

MINDFUL EXPLORERS

1. Head outside and imagine that you are an explorer in a land where humans have never been before.
2. Remain quiet, calm your thoughts and move slowly while you are exploring.
3. Turn your senses of sight, touch and sound onto high.
4. Search for a natural object or a small creature to examine.

- What does it look like?
- What colour is it?
- What does it smell like?
- Can you touch it safely?
- What does it feel like?
- How does it move?
- What shapes and lines can you see in it?



SENSE COUNTDOWN

1. Sit or stand straight and still. Close your eyes or look downward.
2. Take three deep breaths in and out.
3. Open your eyes.
 - Notice **five** things you can see.
 - Notice **four** things you can touch.
 - Notice **three** things you can hear.
 - Notice **two** things you can smell.
 - Notice **one** thing you can taste.



HEARTBEAT

1. Sit straight and still. Close your eyes or look downward.
2. Take three deep breaths in and out.
3. Place your fingers or hands over the part of your body where you can best feel your pulse (or heartbeat):
 - on the side of your neck, under your jaw
 - inside your wrist
 - over your heart
4. Notice how quickly or slowly your heart is beating.
5. Think about your current feelings.

Do you think this feeling is connected to how quickly or slowly your heart is beating?
6. Without speaking, stand up and jump on the spot ten times.
7. Sit down and find your heartbeat again.

What changes do you notice? Is your heart beating faster or slower than you expected?
Can you notice any change in your breath?

8. Close your eyes and focus on your heartbeat until it slows down again.

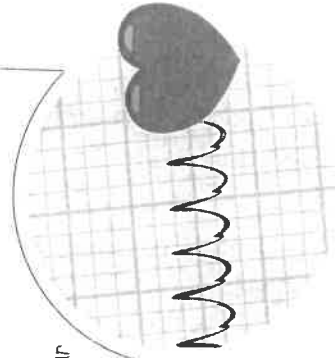

What was your favourite part of yesterday?

 teachstarter

Write a thank you card to someone.

 teachstarter

Which season are you most grateful for and why?

 teachstarter

What is your favourite activity to do?

 teachstarter

Write about a time you were able to help someone.

 teachstarter

What is one special skill you have that you feel proud of?



What is your favourite day of the week and why?



Write about your favourite place outdoors.



Write about your favourite place indoors.



What is one of your happiest memories?



Think of one person in your family and write about why you are so grateful for them.

 teachstarter

What do you love most about yourself and why?

 teachstarter

Write about your favourite time of day.

 teachstarter

Who is someone that inspires you?

 teachstarter

What is the best thing about where you live?

 teachstarter

Write about a challenge you've overcome.



What is something you are looking forward to?



When was the last time you felt really sad? What is something good that came out of that feeling?



What have you created that makes you feel proud?



Write about an opportunity you've had to learn something new.



Describe your favourite taste and how it makes you feel.

 teachstarter

What do you love most about your body?

 teachstarter

Describe your favourite celebration.

 teachstarter

What is one thing you can't stop thinking about?

 teachstarter

What is a big change in the world that you'd like to make?

 teachstarter

Write a list of your five favourite places and why you are grateful for them.

 teachstarter

What is a talent that you have used today?

 teachstarter

Write about the last time someone made you laugh.

 teachstarter

Write about the last time someone made you smile.

 teachstarter

What is something or someone who makes you feel safe?

 teachstarter

How are you able to help people in need?

 teachstarter

What mistake are you grateful for?

 teachstarter

List five ways you can share happiness with others today.

 teachstarter

What hobbies or activities would you miss if you were unable to do them?

 teachstarter

Think about someone in your life who can be hard to get along with. Write down one quality about them that you are grateful for.

 teachstarter

What part of your morning routine are you most grateful for?

 teachstarter

Write about a time someone helped you when you were hurt.

 teachstarter

What is your favourite way to move your body?

 teachstarter

What is your least favourite time of year? Think of three reasons to be grateful for that time of year.

 teachstarter

Think about someone you see every day. What is it about that person that you are most grateful for?

 teachstarter

Think about what life was like one year ago. Write five reasons you are grateful for your experiences since then.

 teachstarter

What is your favourite natural element: earth, air, fire or water? Why?

 teachstarter

What is your favourite colour and why?

 teachstarter

What is your favourite of the five senses: taste, sight, touch, sound or smell? Why are you grateful for this sense?

 teachstarter

Write about three items that you own and feel grateful for.

 teachstarter

*How do your family and friends help
to make your life happy?*

 teachstarter

*What is something you did today that
you'd love to do every day?*

 teachstarter

*How would you rate today from 1 to 10?
Why are you grateful for today?*

 teachstarter

What is your favourite word right now? Why?

 teachstarter

*What part of your evening routine are
you most grateful for?*

 teachstarter

MAKE A PAPER PINWHEEL

YOU WILL NEED:

- Scissors
- Glue stick
- Eraser
- Paper straw
- Map pin or thumbtack
- Stopper (a rubber earring back, a seed bead or a Styrofoam ball)

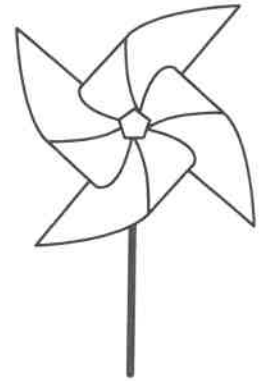

INSTRUCTIONS

1. Colour in the front of your pinwheel and the small pentagon.
2. Cut along the black lines.
3. Glue each of the black dots into the centre, one on top of another.
4. Glue the pentagon on top, in the centre of the pinwheel.
5. Pinch one end of the paper straw to make it flat.
6. Lay the flat end of the straw on the eraser, and place the centre of the pinwheel on top of it.
7. Very carefully push your pin through all the layers of your pinwheel and the straw.
8. Pull the eraser off and put a stopper on the point of the pin.

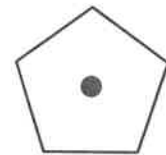

A Pin Free Alternative

Use a medium paper fastener (split pin) instead.

Use a hole punch to form large holes on each dot. Fasten and open the split pin. Pinch the top of the paper straw together and cut a 1 cm slit down the centre. Slide the split pin into the slit in the paper straw.

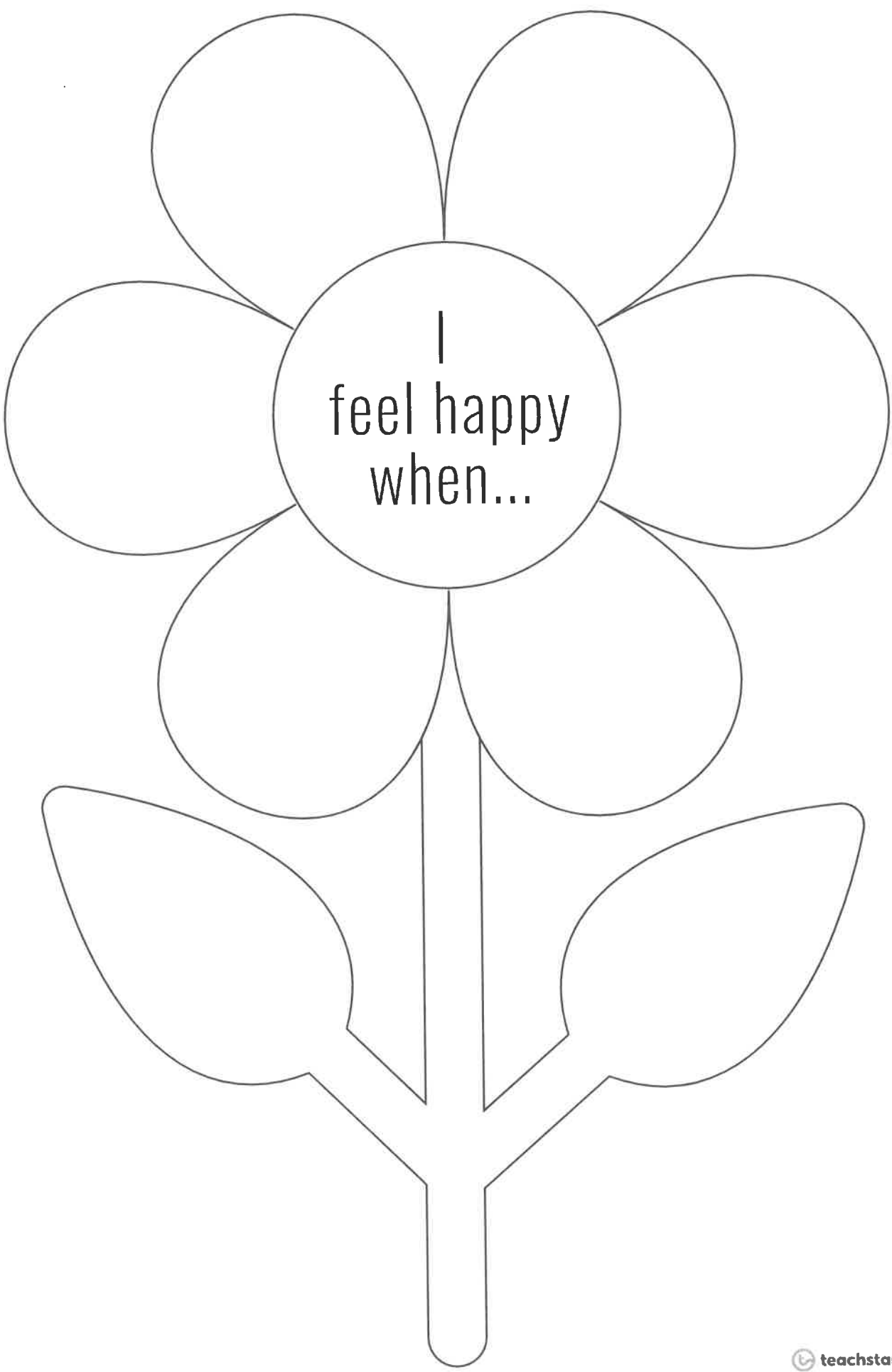

I
feel happy
when...

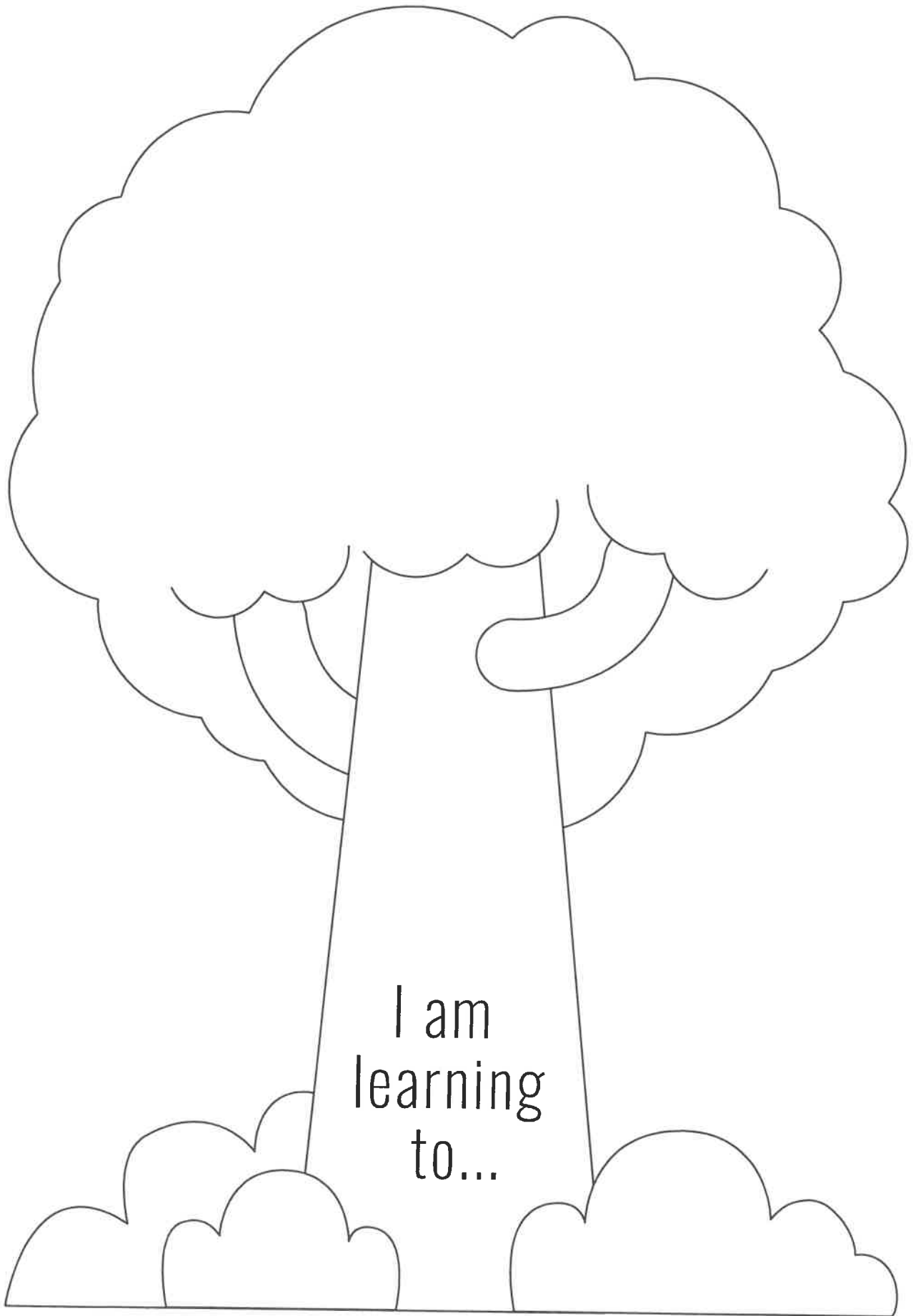

I am
learning
to...

On the inside, I am...

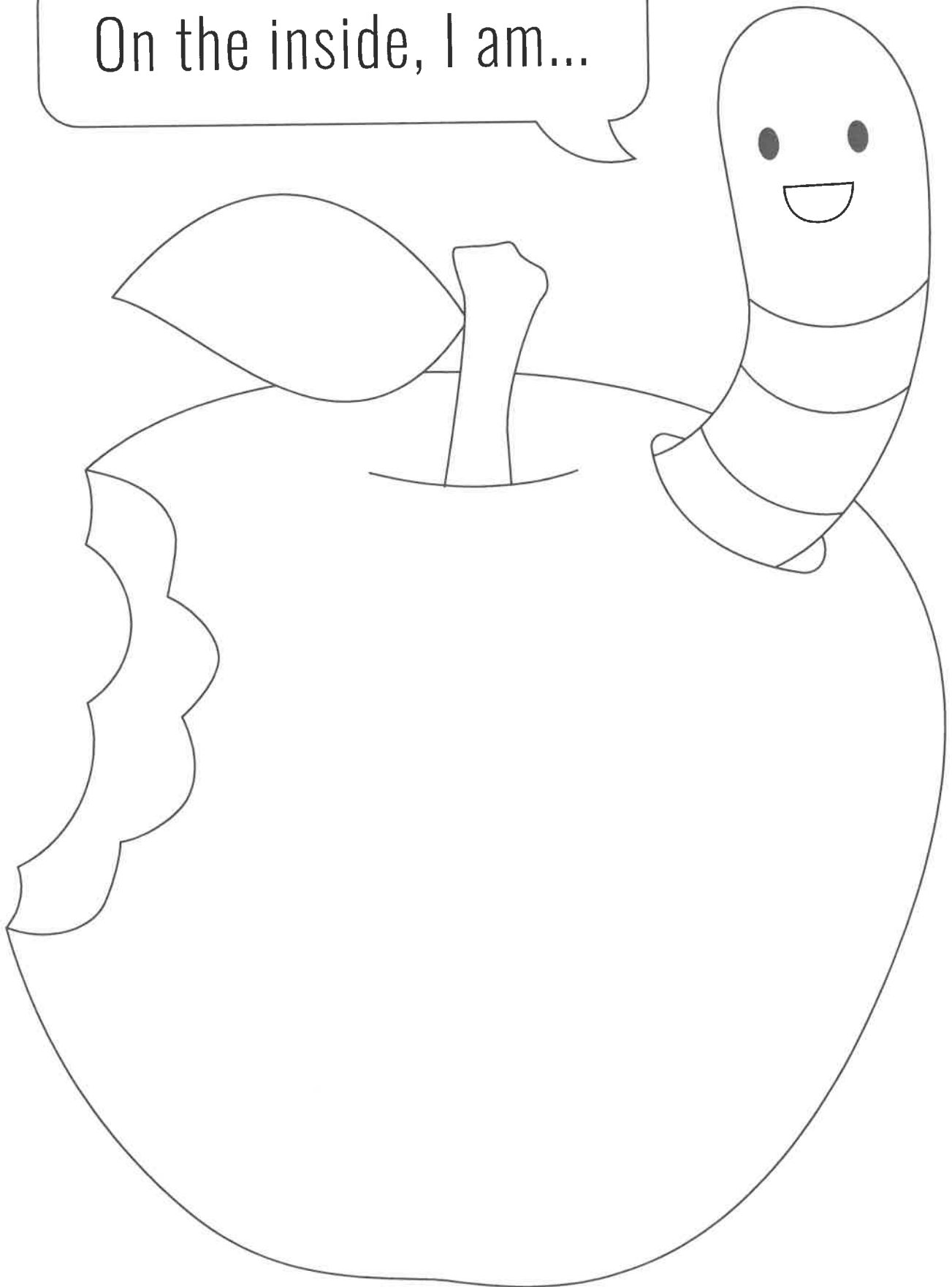

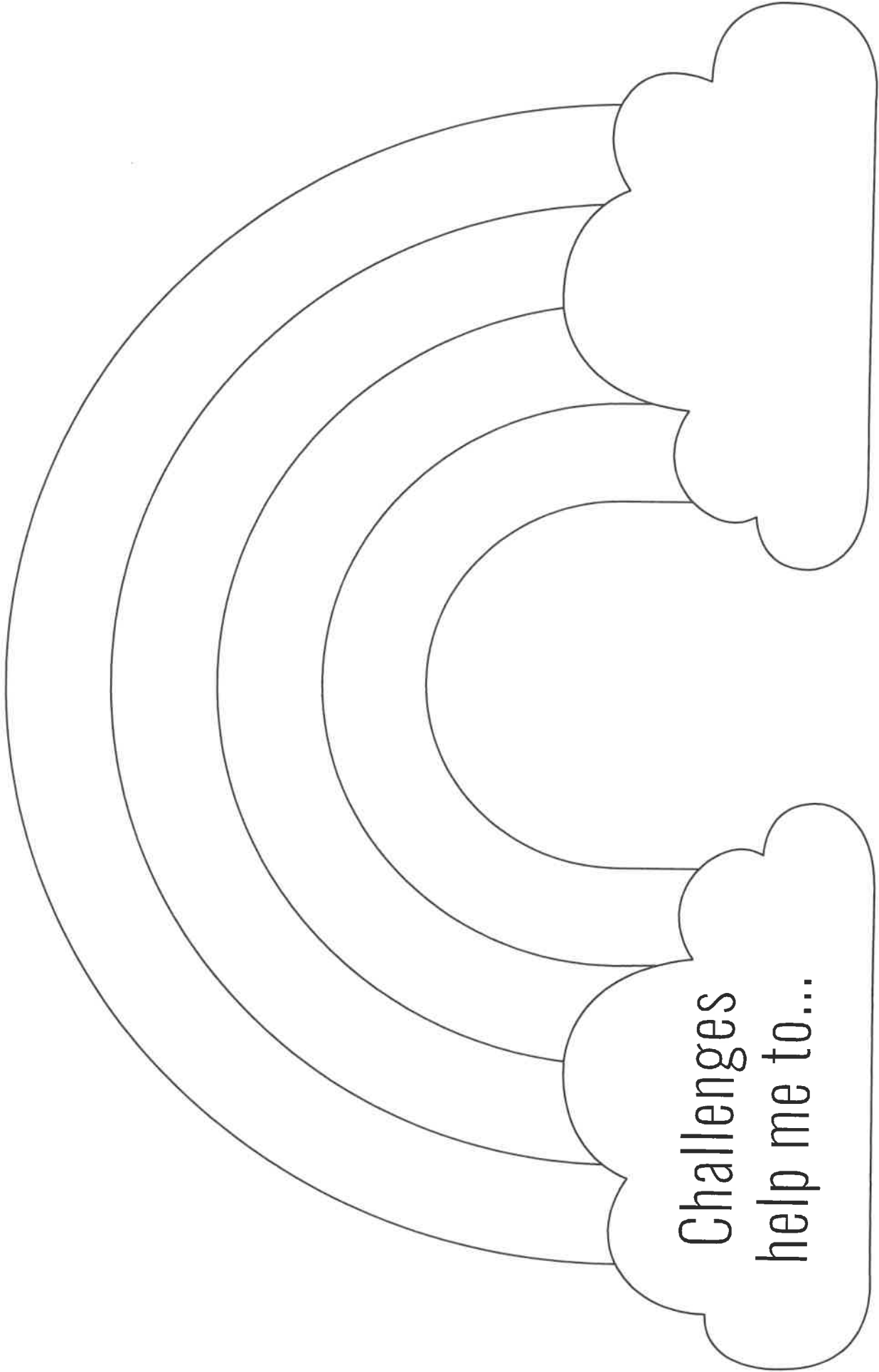

Challenges
help me to...

I am curious about...

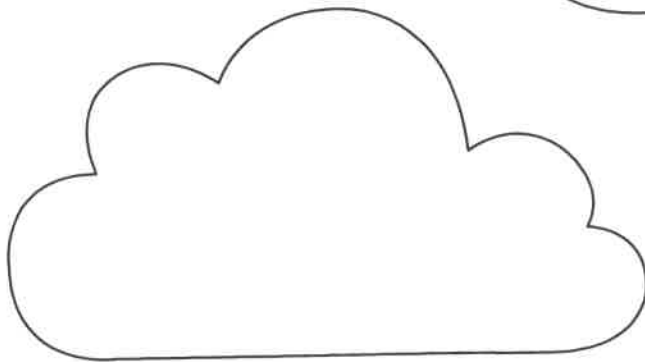
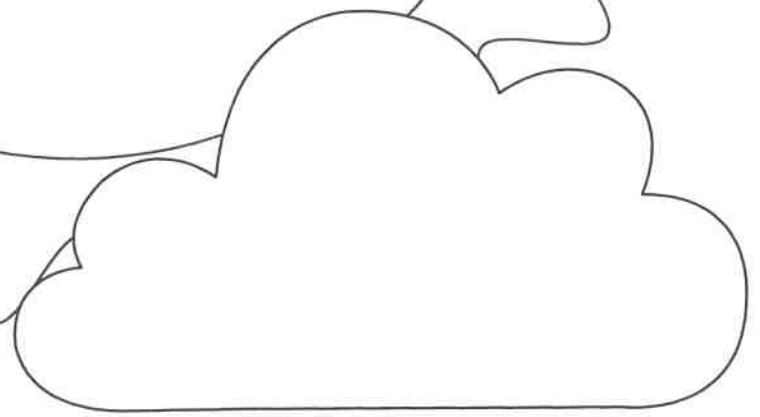

Tree

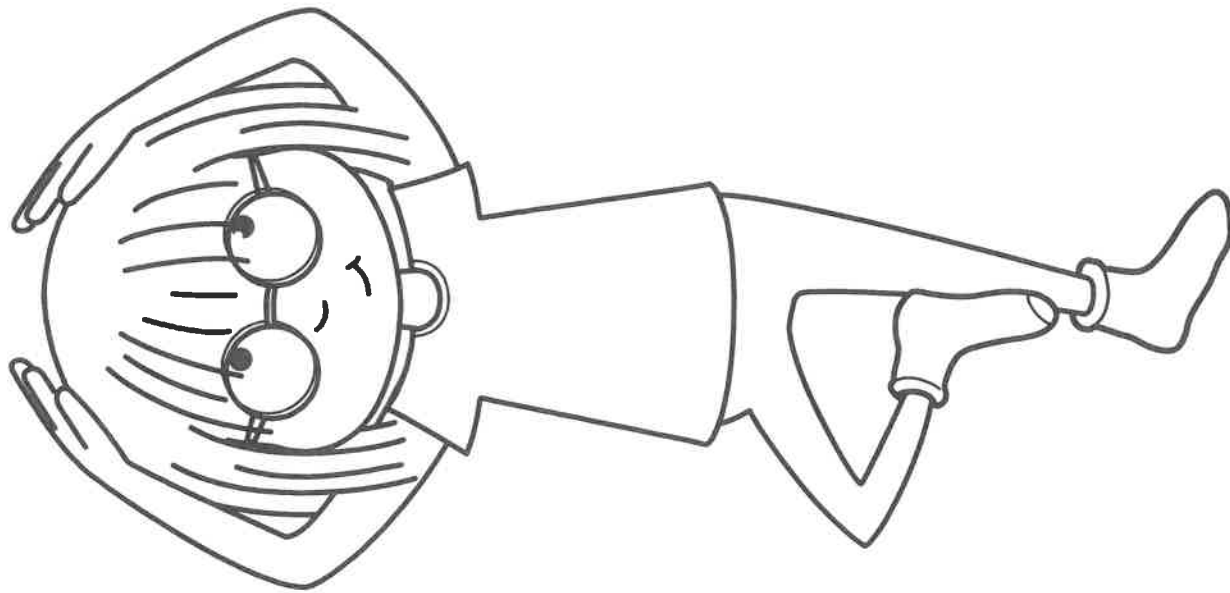

Warrior

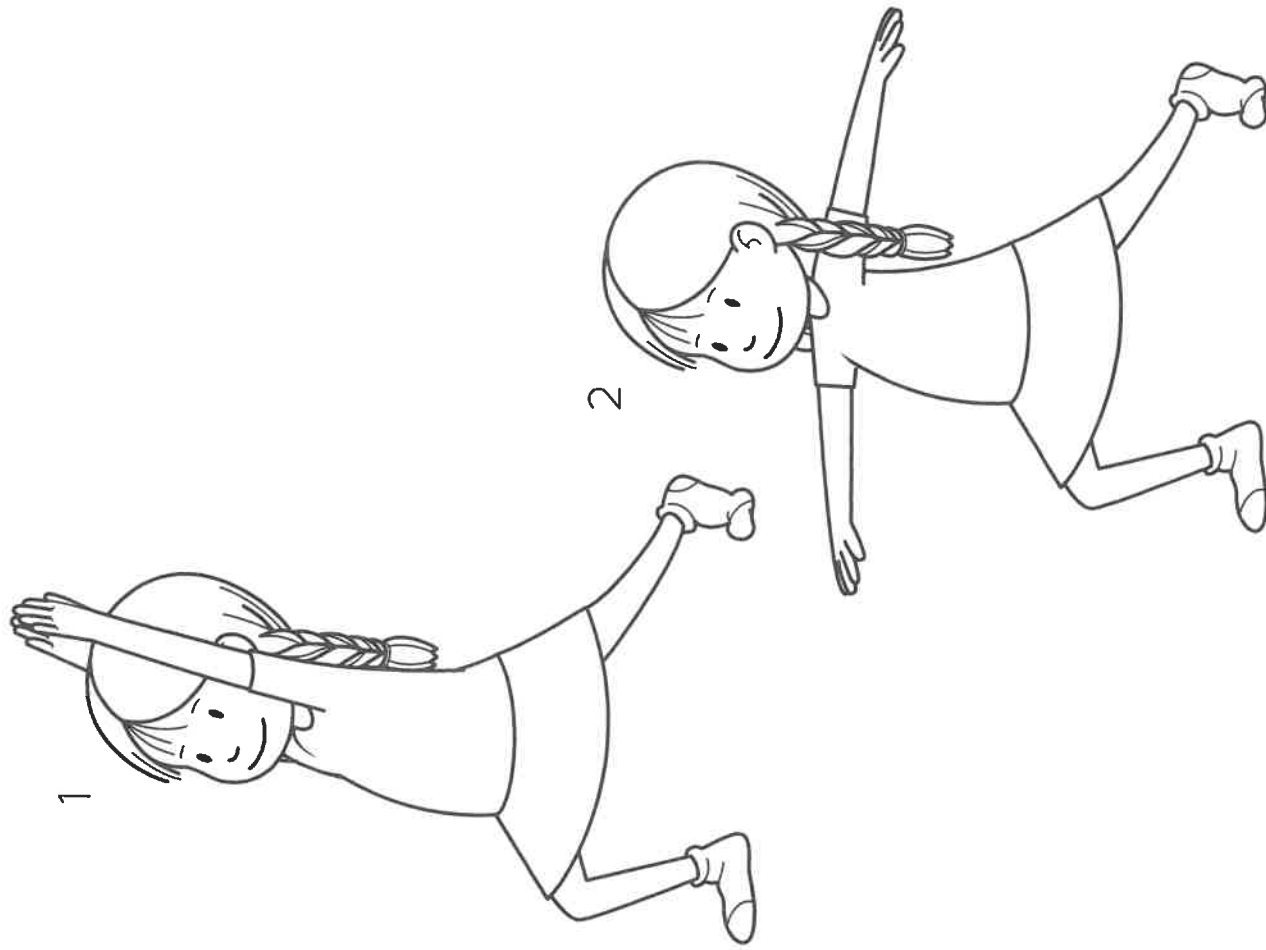

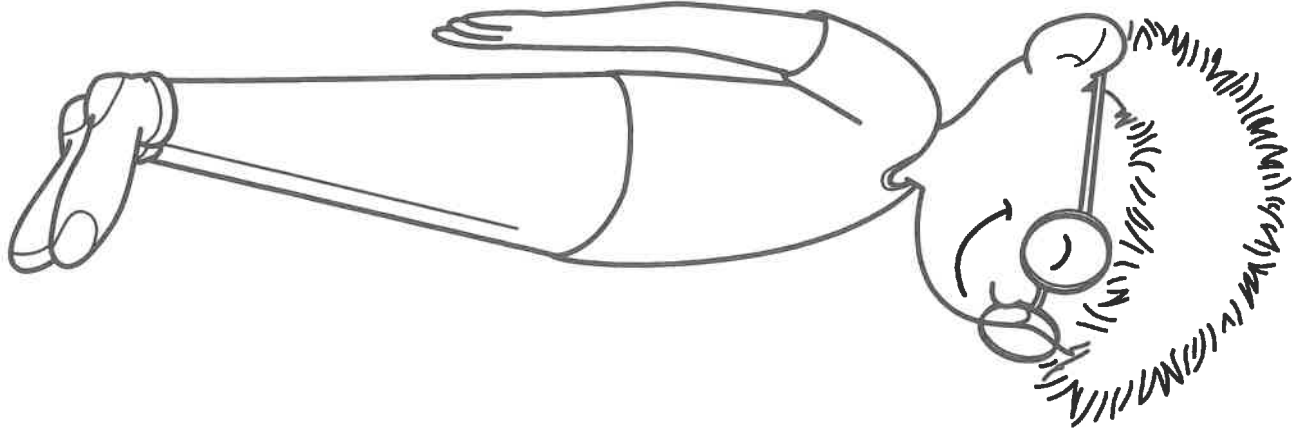

Relaxation

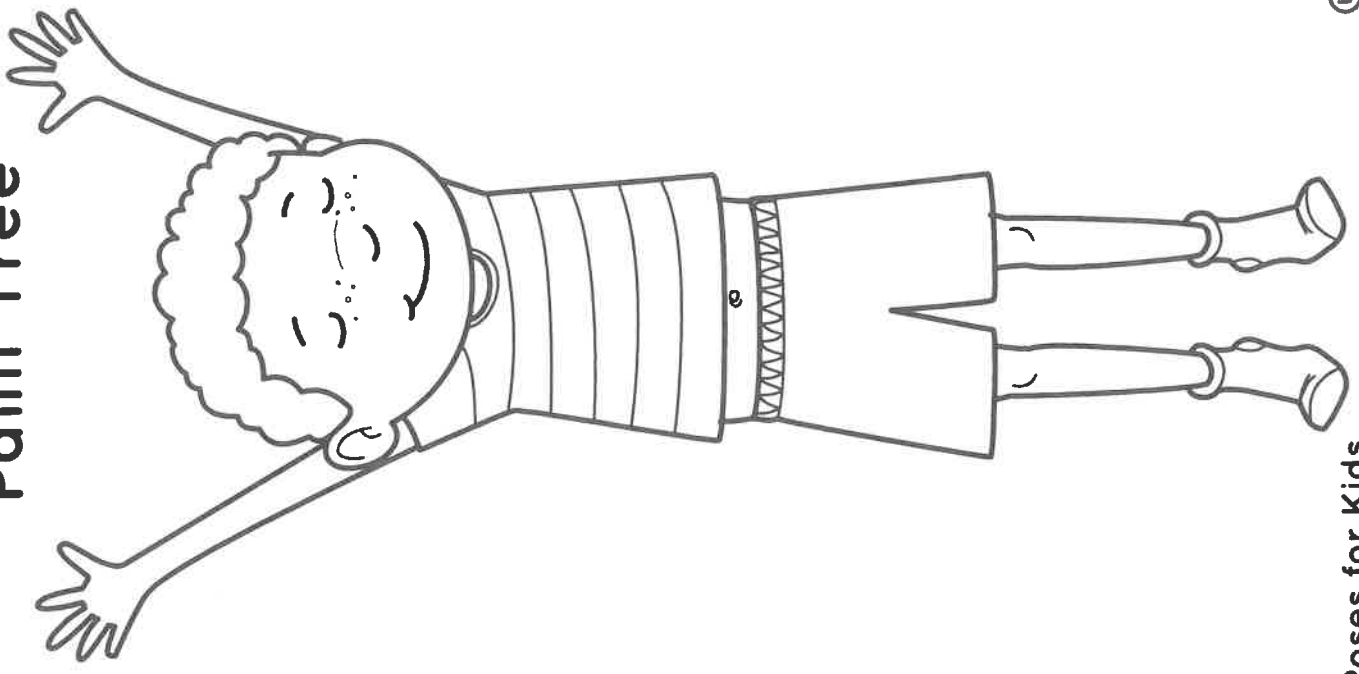

Palm Tree

Frog

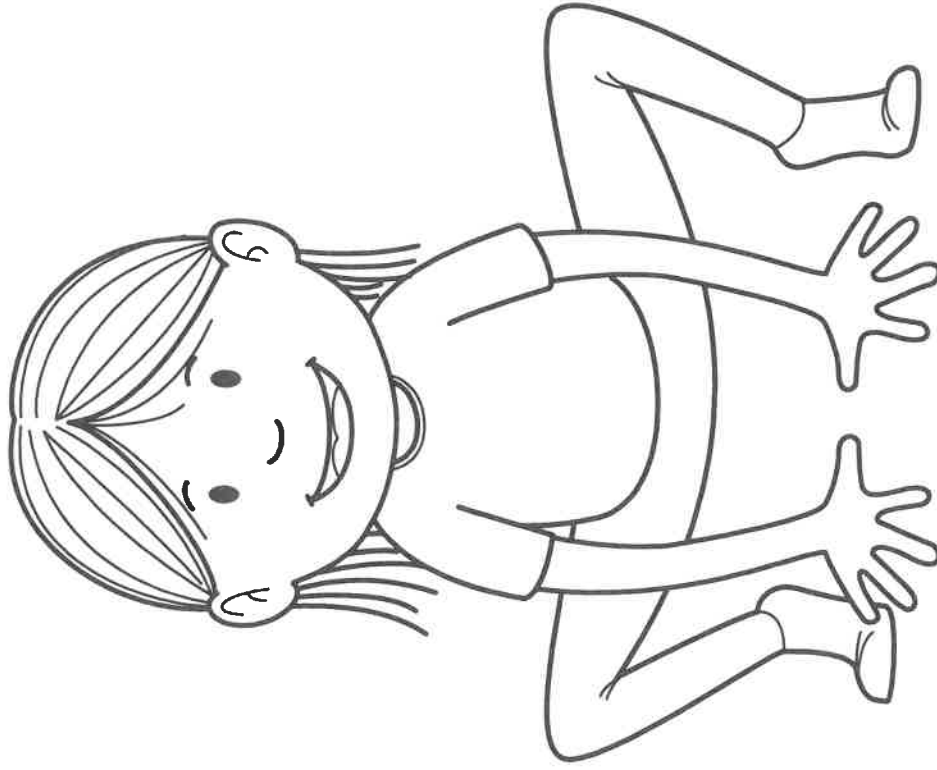

Ragdoll



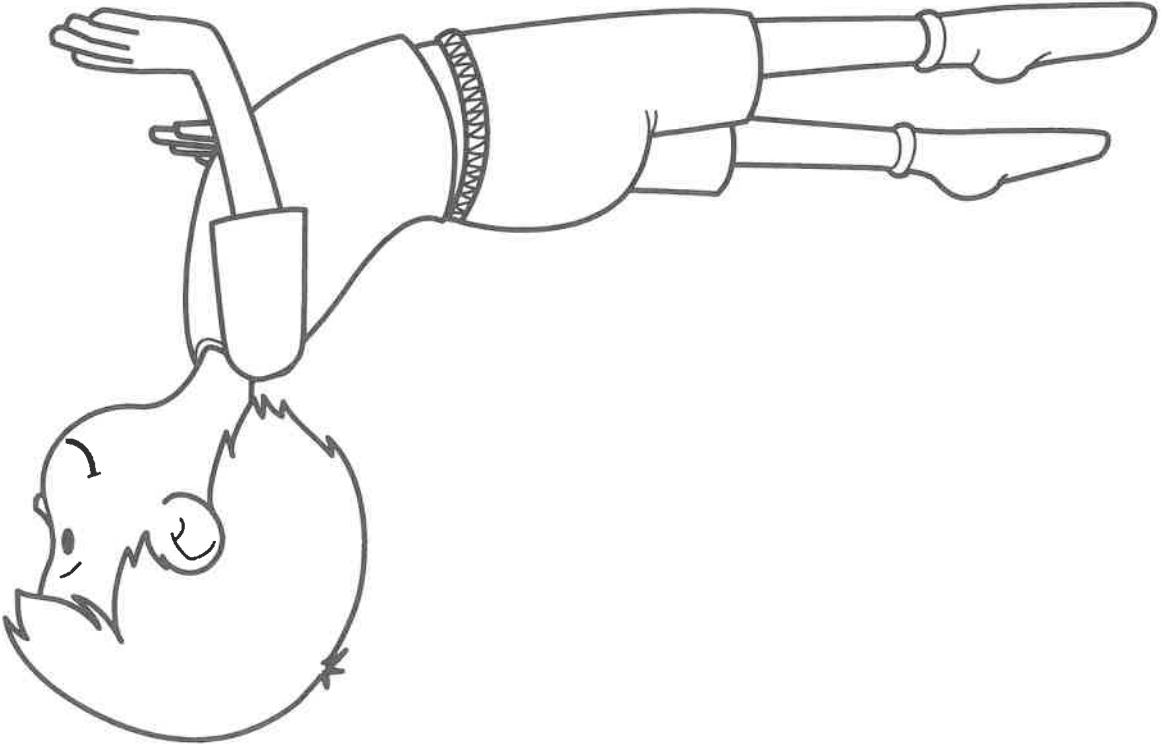

Up dog

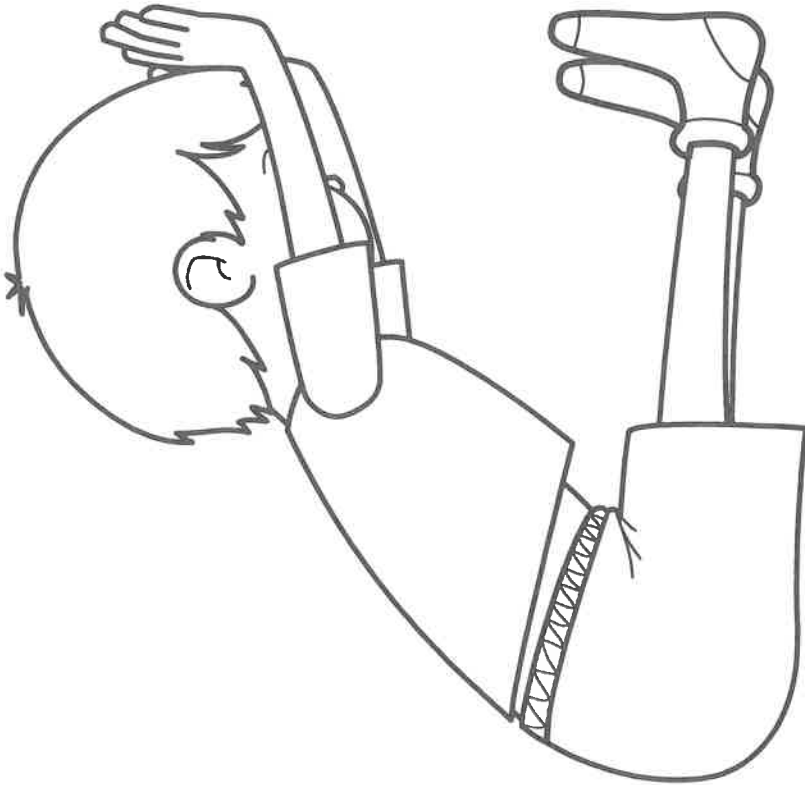

Down Dog

Cow

1



Cat

2



Bridge

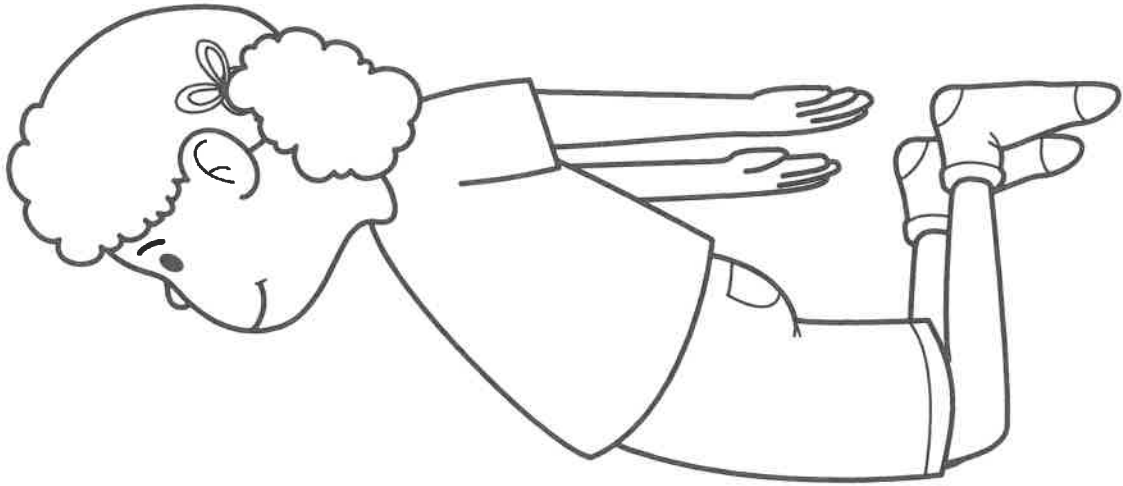

Yoga Poses for Kids

© teachstarter

Yoga Poses for Kids

© teachstarter

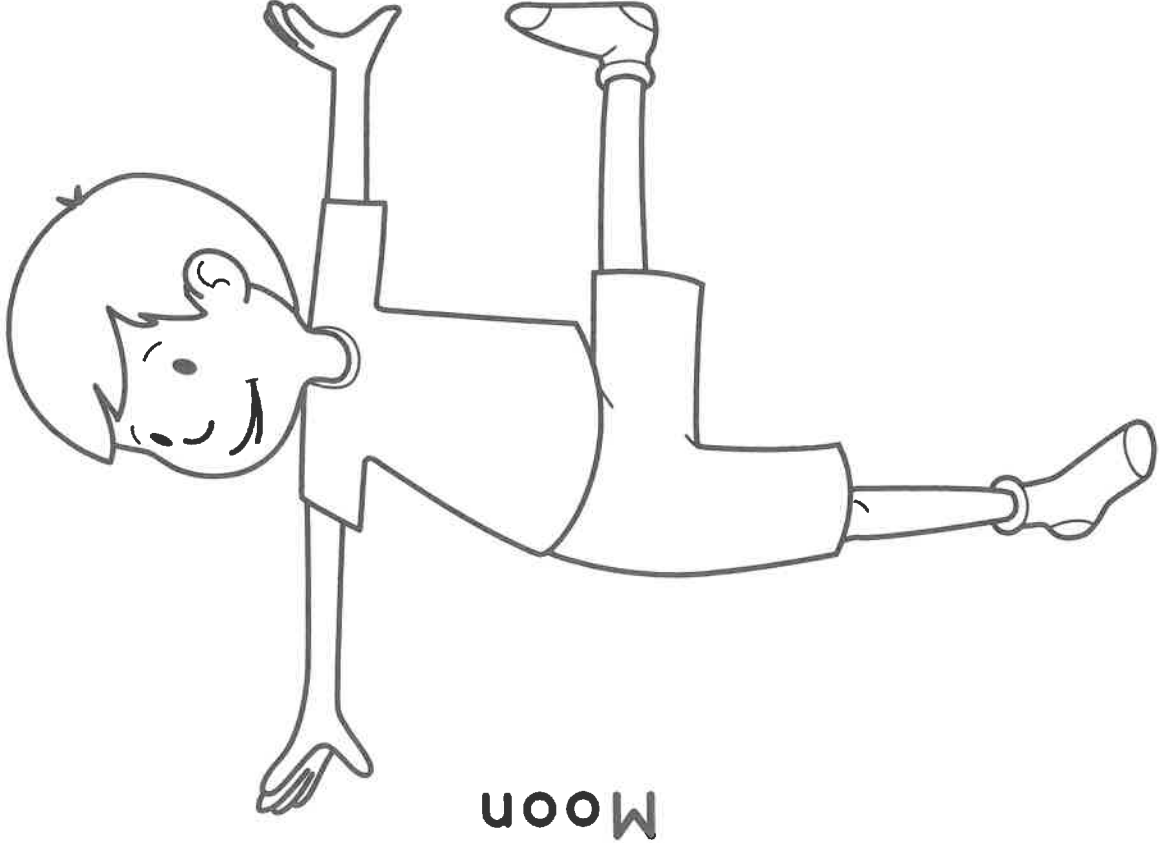

Moon

Rainbow

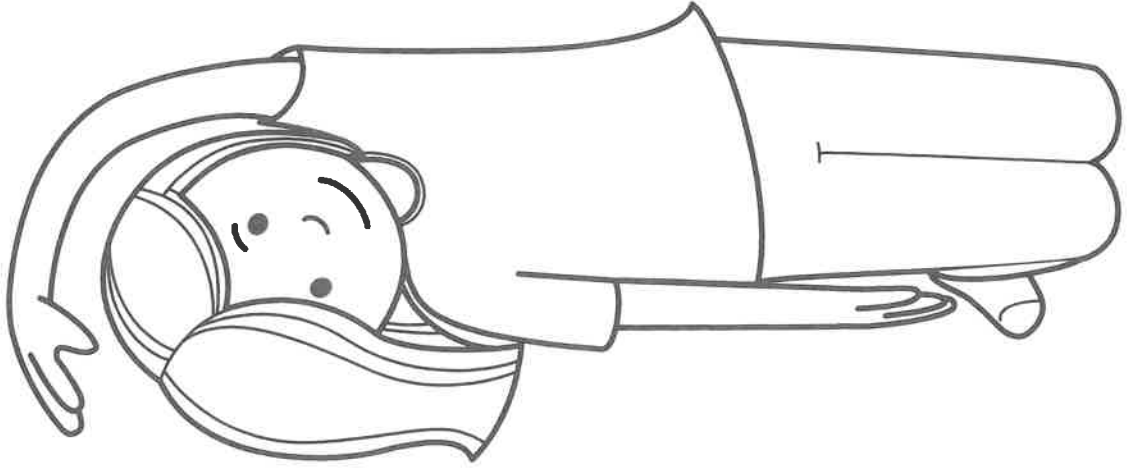

Butterfly

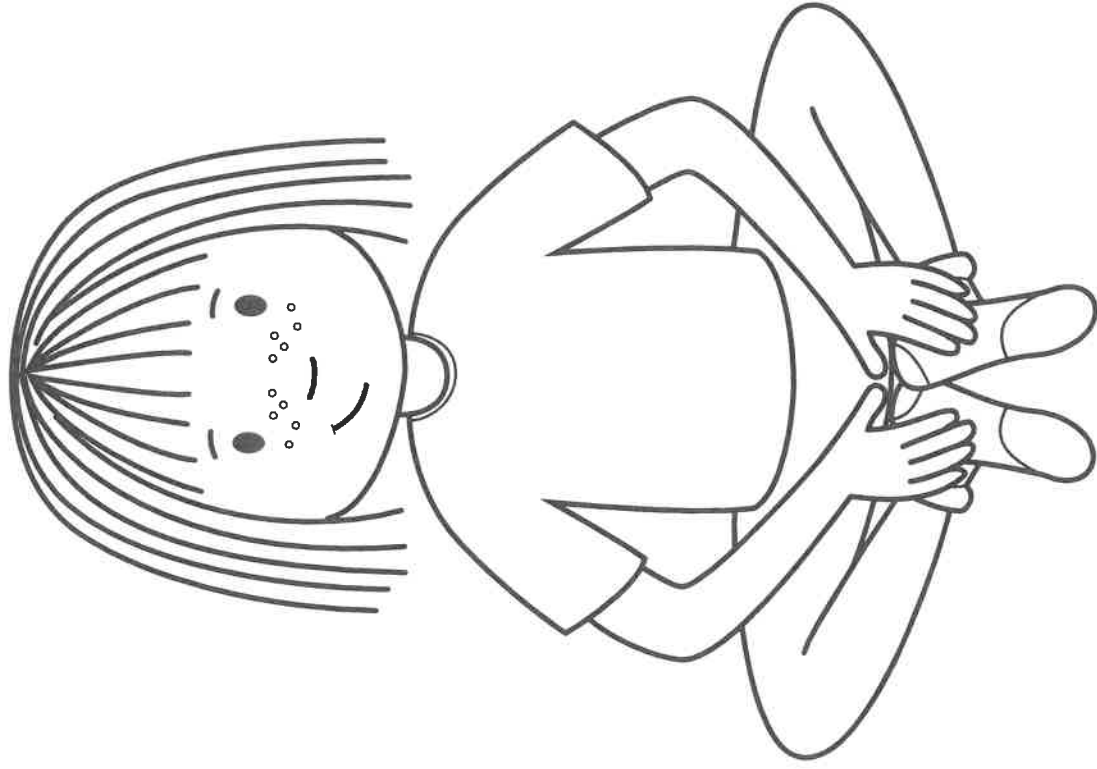

Yoga Poses for Kids

© teachstarter

Star

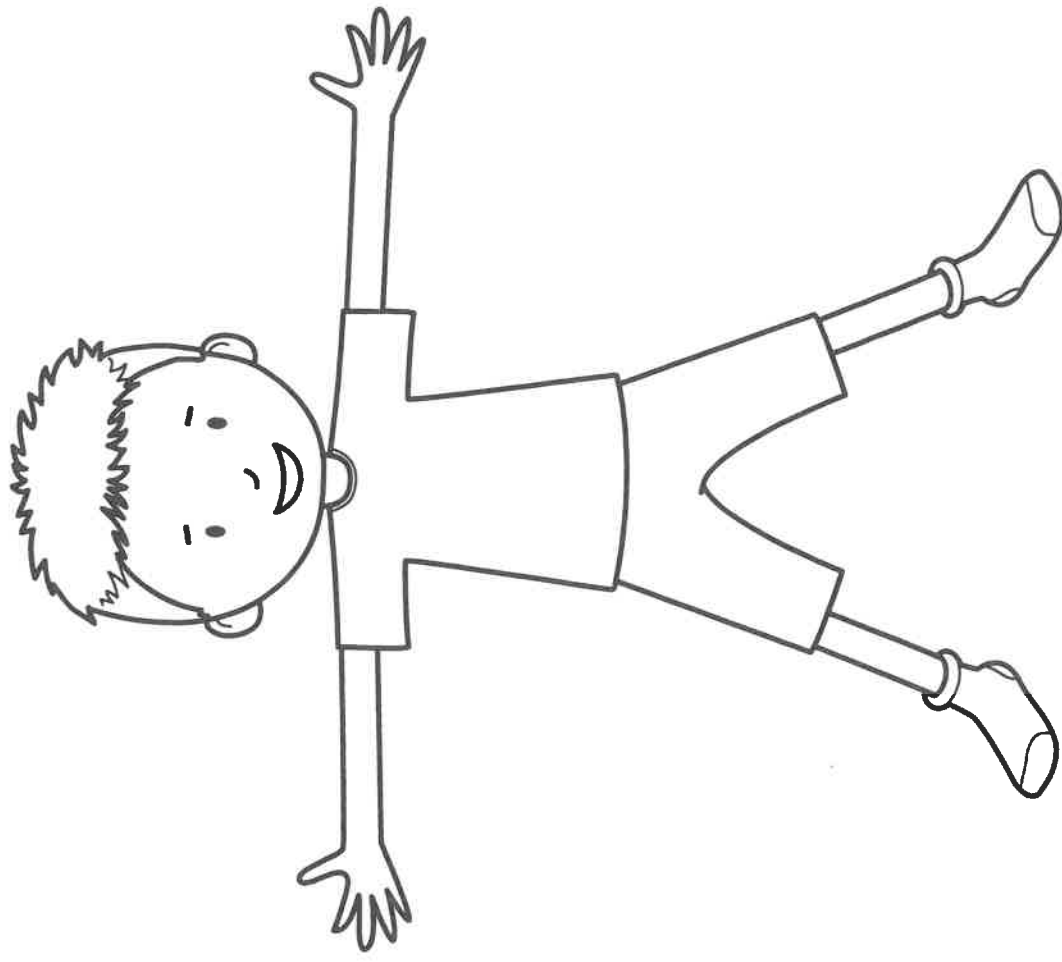

Yoga Poses for Kids

© teachstarter

Dancer

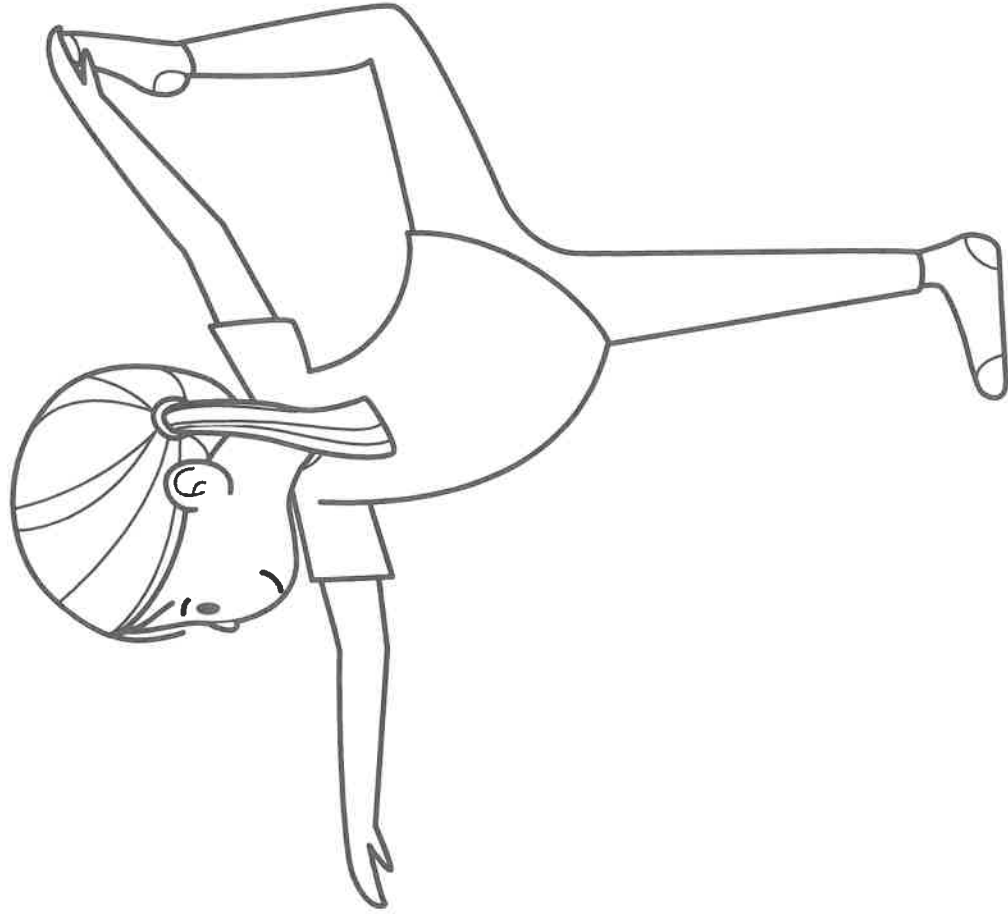

Child's Pose

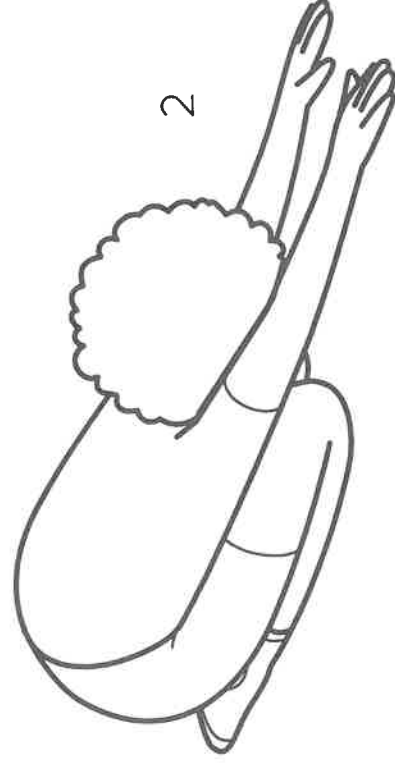
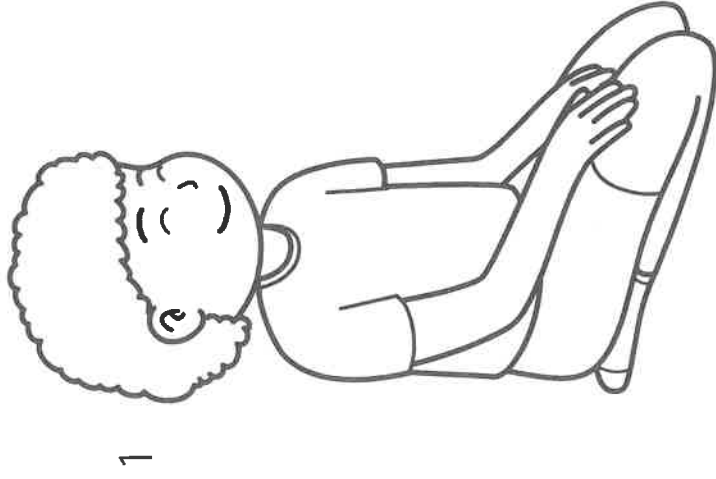





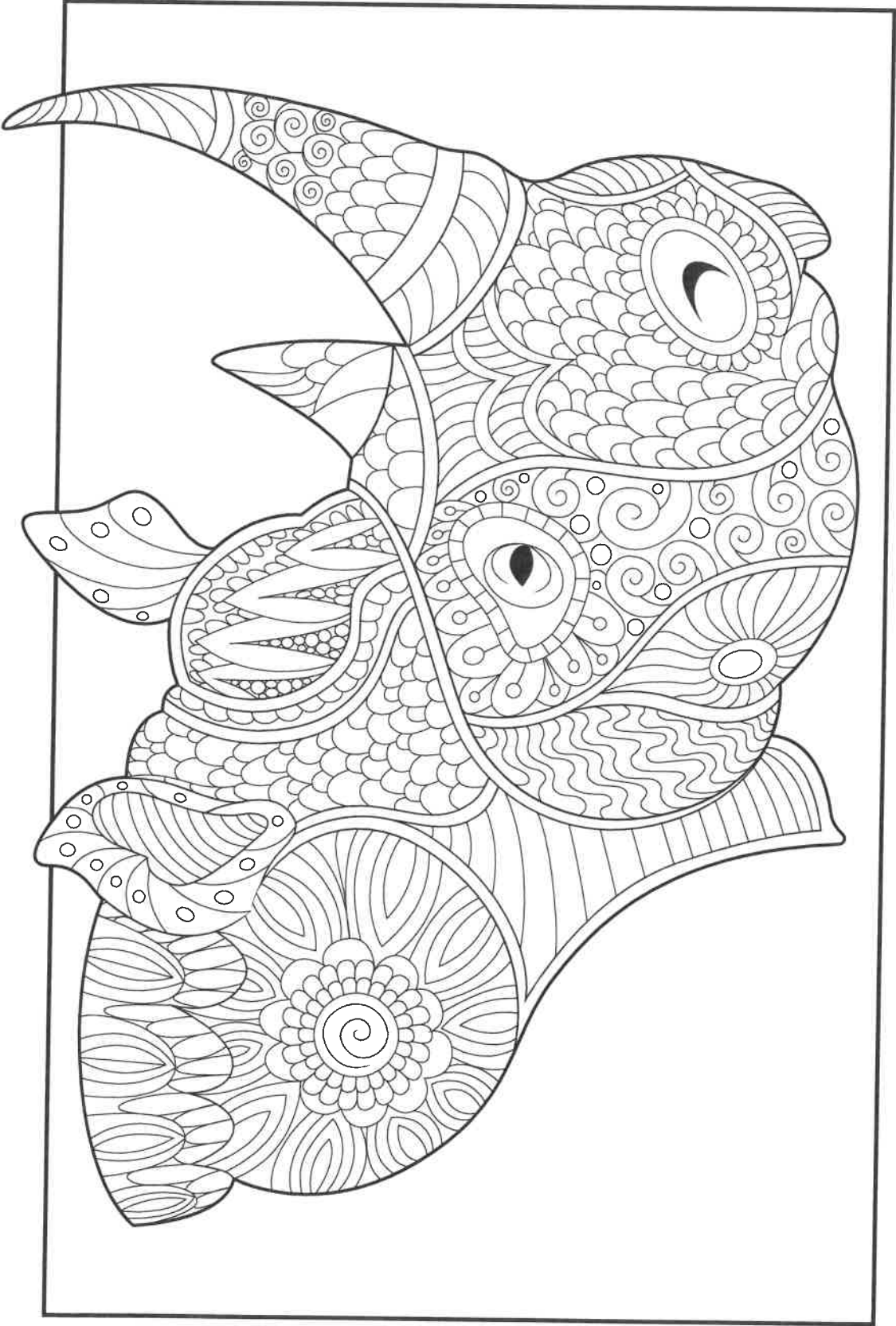

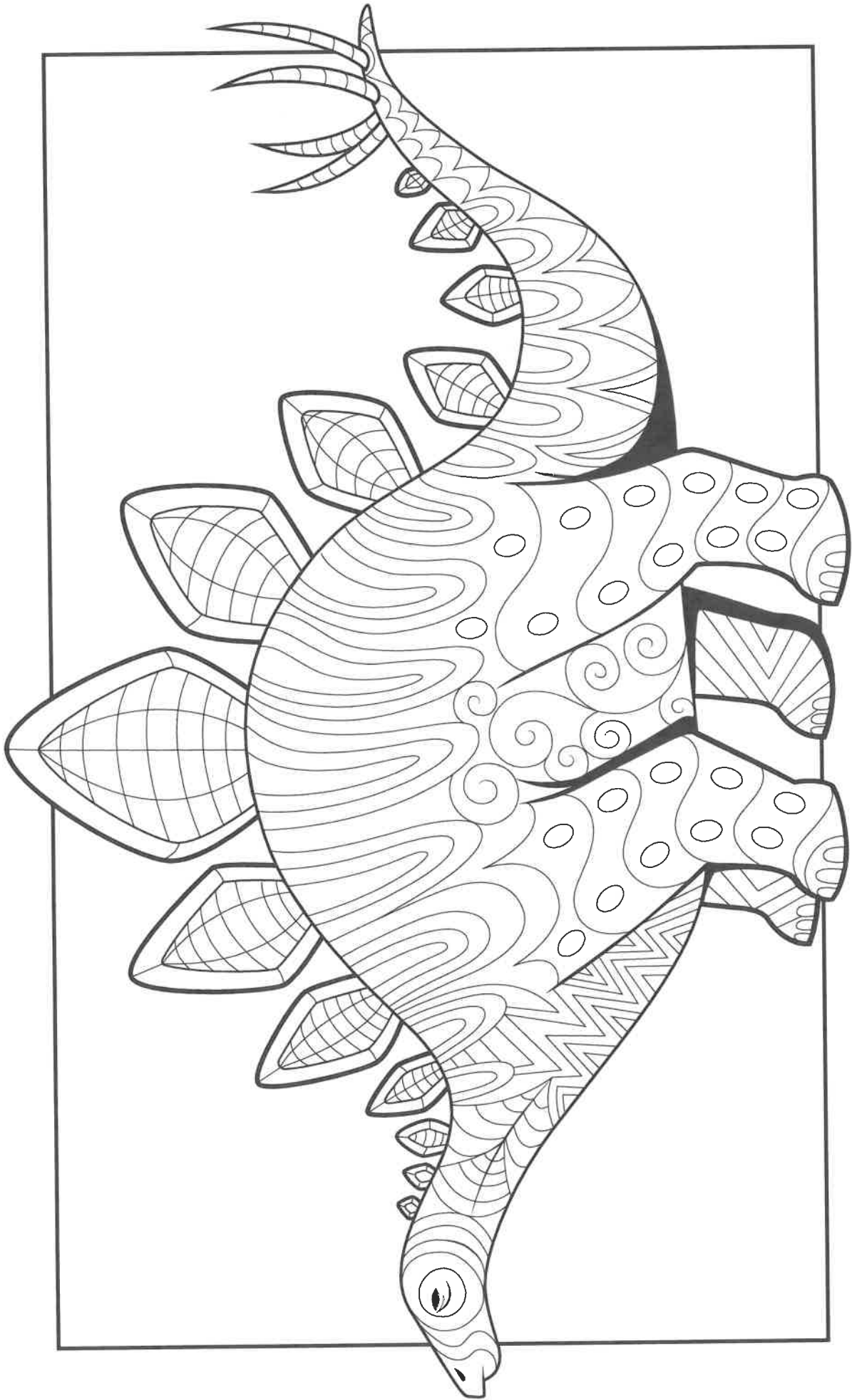

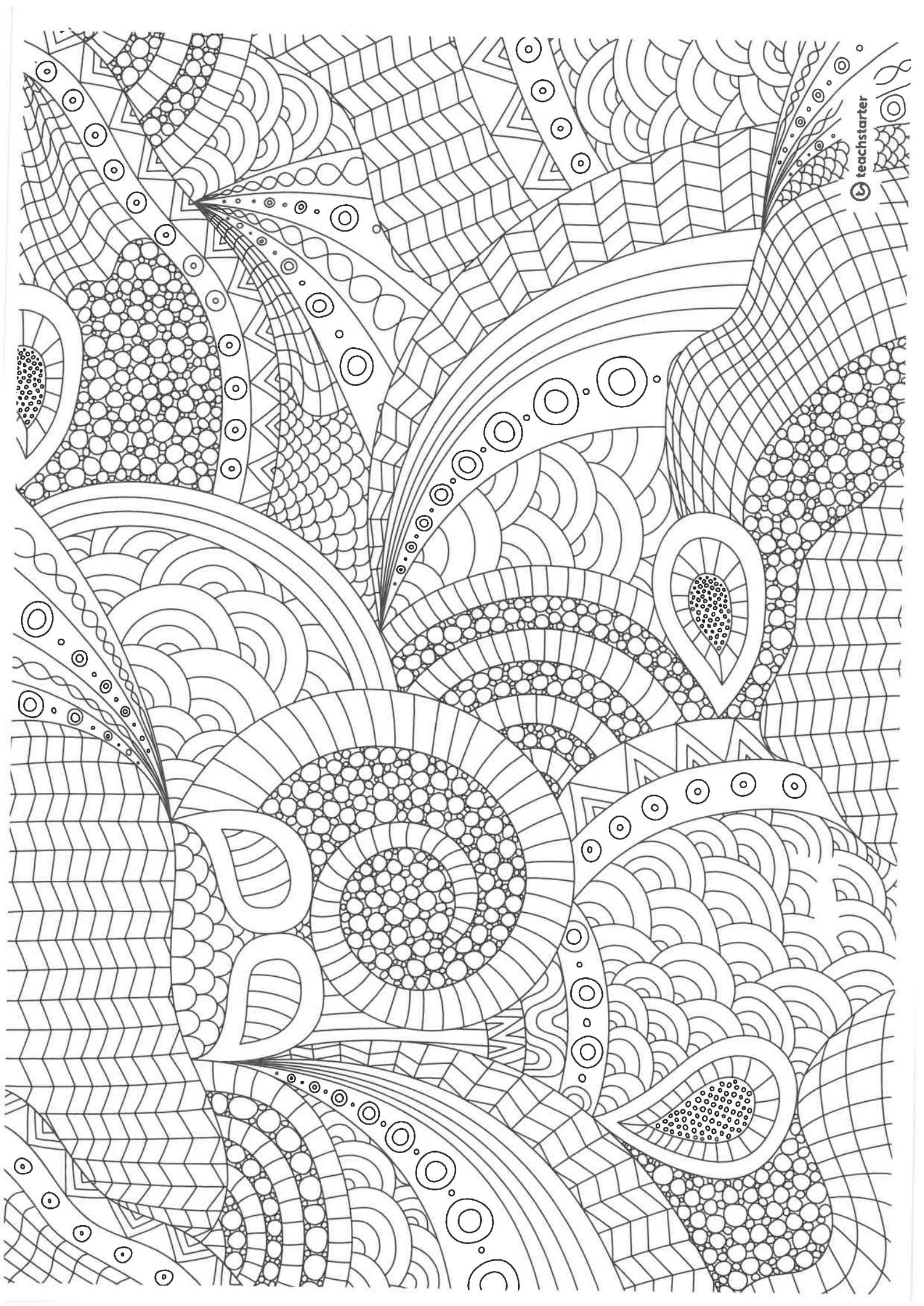

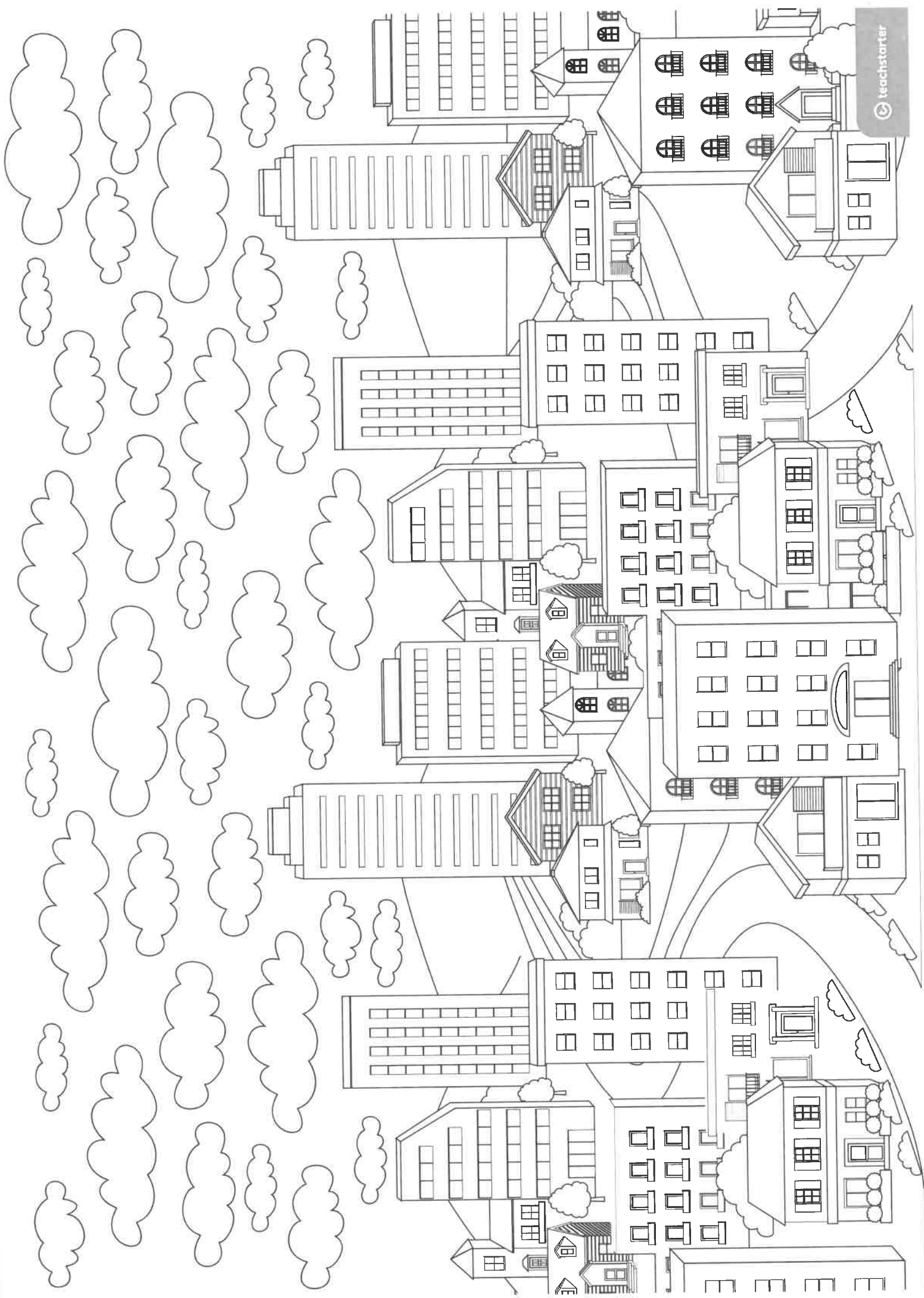

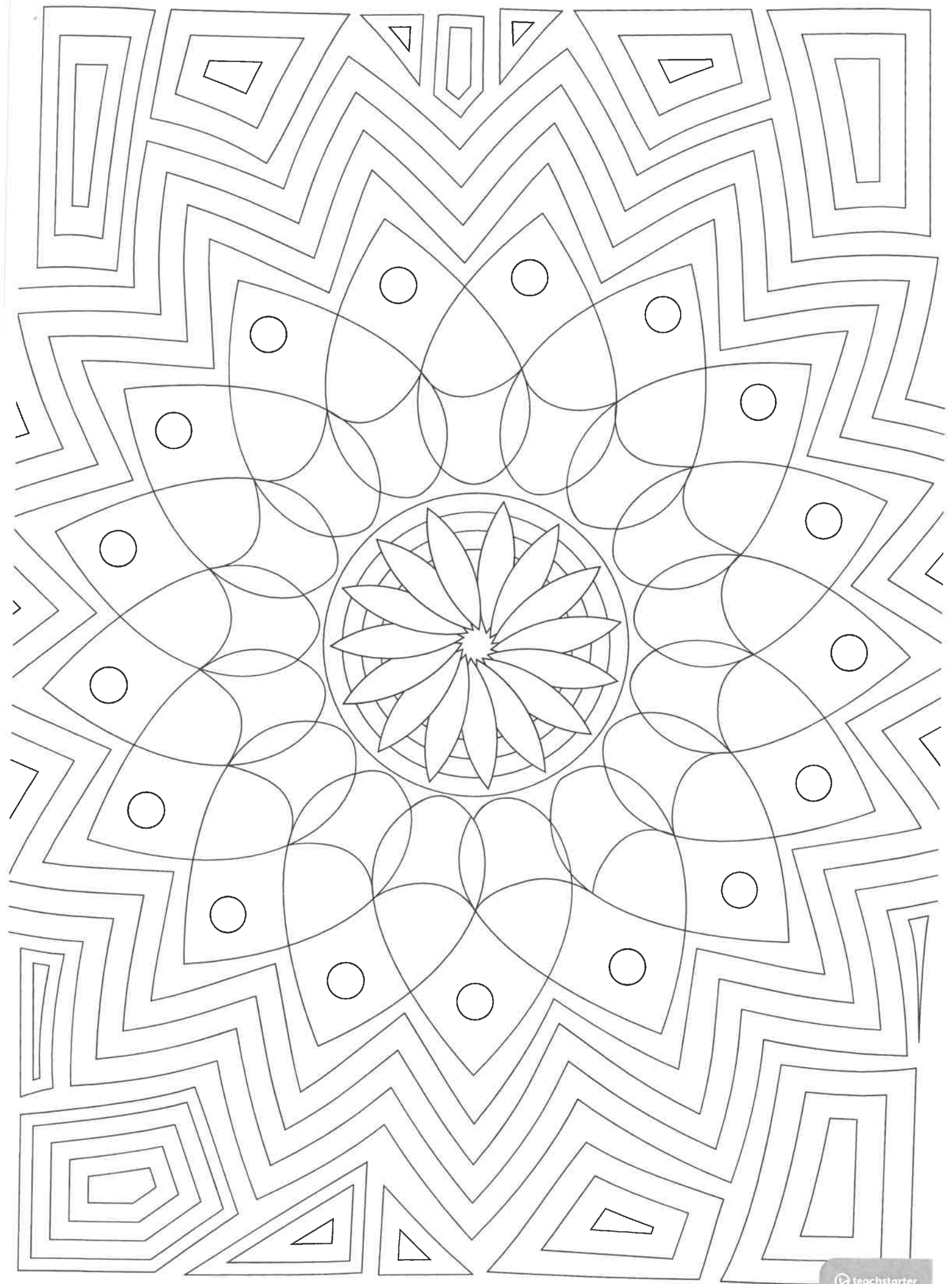

EVERY DAY
MAY NOT be
GOOD BUT THERE
IS SOMETHING
good IN EVERY
DAY

